



ELORA - Rauch Family



One family. One idea. In 1924, Erich Rauch founded the company that is known today as ELORA, which successfully manufactures and sells tools worldwide. From the very beginning, family cohesion was a central building block for success. Many family members worked in the company right from the start, and this is still the case today.



01

ASSORTMENTS AND STORAGE UNITS



Roller Tool Cabinets, Tool Boxes, _____	Page 28
Accessories _____	
Tool Modules _____	Page 40
Tool Assortments _____	Page 67

1220-L7

ROLLER TOOL CABINET SUPER CADDY

01

- with 7 drawers
- solid metal sheet pattern, ELORA-yellow (RAL 1006)
- corrosion- and scratch-resistant powder-coating
- shelf space on the top made of ABS plastic with 7 storage compartments for small parts and rim on all sides
- 200 kg shelf load capacity due to strengthened top cover
- solid handlebar, mounting possible on both sides
- sides and back panel with Euro-Perforation 10 x 38 mm (hole square 10 x 10 mm, hole centre-hole centre 38 x38 mm) for mounting accessory hooks, trays, waste basket, can holder, paper roll holder, cable drum
- central locking system with cylinder lock and 2 keys
- loading capacity of each drawer 40 kg
- each drawer has a safety locking system and is 100% extractable
- drawer with ball bearing guide rails
- drawer internal measurements W 573 x D 410 mm
- drawers ELORA-black powder-coated (RAL 9005)
- can be individually divided with separators or equipped with ELORA-OMS modules
- total loading capacity 300 kg
- broad gauge running gear with 4 Ø 125 mm full rubber, smooth running castors, 2 swivel castors with double break function (tangential and axial)
- dividers for drawers separately available
- delivery without tools and accessories
- suitable assortments: WS and OMS
- **accessories can be found on www.elora.de**

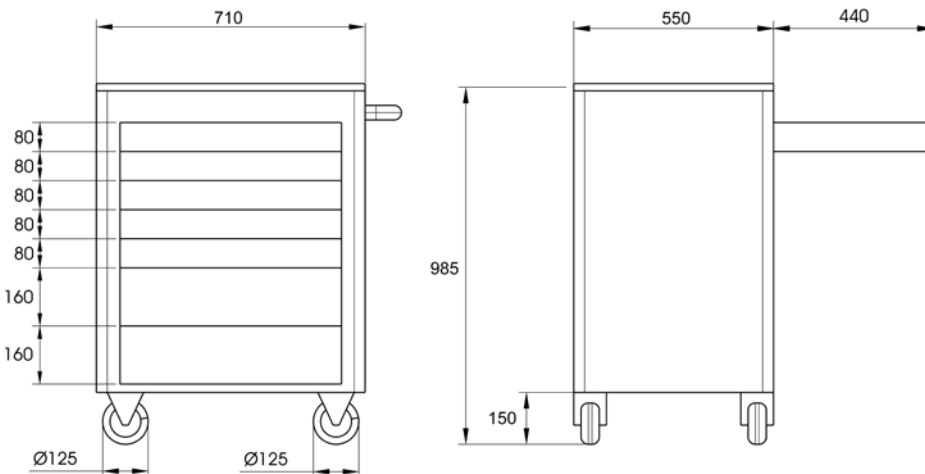

Code	Number	Height mm	Width mm	Depth mm	Loading Capacity kg	Pieces	Weight/g
1220000006000	1220-L7	985	710	550	450	1	78000

1220-L

ROLLER TOOL CABINET SUPER CADDY 100

- with 7 drawers
- solid metal sheet pattern, ELORA-yellow (RAL 1006)
- corrosion- and scratch-resistant powder-coating
- storage surface made of PS (polystyrene), solvent-resistant, with integrated storage compartments
- very sturdy double-walled sheet steel construction
- with lateral perforated wall
- solid handlebar, mounting possible on both sides
- sides panel with Euro-Perforation
- central locking system with cylinder lock and 2 keys
- loading capacity of each drawer 45 kg
- 7 drawers with ball bearings and full-extension runners
- individual drawer locking over the whole ledge (one-hand operation)
- anti-tilt device (prevents several drawers from opening at the same time)
- drawer internal measurements W 573 x D 410 mm
- drawers ELORA-black powder-coated (RAL 9005)
- total loading capacity 450 kg
- broad gauge running gear with 4 Ø 125 mm full rubber, smooth running castors, 2 swivel castors with double break function (tangential and axial)
- delivery without tools and accessories
- suitable assortments: WS and OMS
- combinable with tool chest ELORA-No. 1221-L
- **other drawer types and special colours on request**
- **accessories can be found on www.elora.de**



You will find the matching tool chest 1221-L on page 32

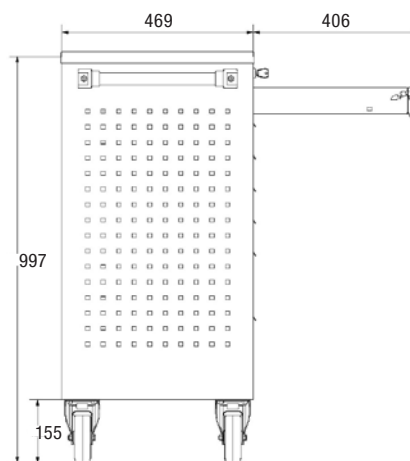
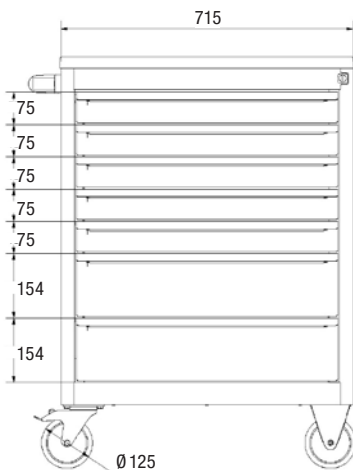

Code	Number	Height mm	Width mm	Depth mm	Loading Capacity kg	Pieces	Weight/g
1220000006100	1220-L	997	715	469	450	1	61500

1215-L

ROLLER TOOL CABINET CADDY 100

- with 7 drawers
- solid metal sheet pattern, ELORA-yellow (RAL 1006)
- corrosion- and scratch-resistant powder-coating
- storage surface made of PS (polystyrene), solvent-resistant, with integrated storage compartments
- solid handlebar, mounting possible on left sides
- central locking system with cylinder lock and 2 keys
- loading capacity of each drawer 45 kg
- 7 drawers with ball bearings and full-extension runners
- individual drawer locking over the whole ledge (one-hand operation)
- drawer internal measurements W 573 x D 410 mm
- drawers ELORA-black powder-coated (RAL 9005)
- total loading capacity 450 kg
- broad gauge running gear with 4 \varnothing 125 mm full rubber, smooth running castors, 2 swivel castors with double break function (tangential and axial)
- delivery without tools and accessories
- suitable assortments: WS and OMS
- combinable with tool chest ELORA-No. 1221-L
- **other drawer types and special colours on request**
- **accessories can be found on www.elora.de**



You will find the matching tool chest 1221-L on page 32

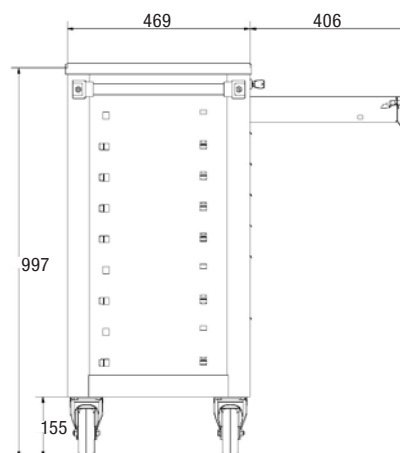
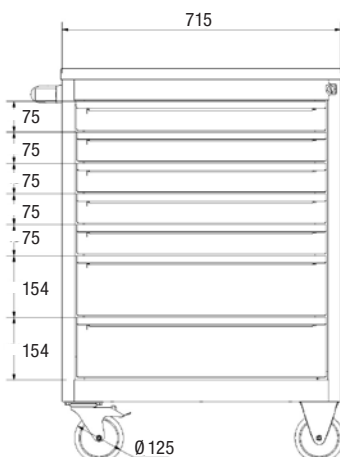

Code	Number	Height mm	Width mm	Depth mm	Loading Capacity kg	Pieces	Weight/g
1215000006100	1215-L	997	715	469	450	1	57000

1200-L

SERVICECAR BUGGY 100

- solid metal sheet pattern, ELORA-yellow (RAL 1006)
- corrosion- and scratch-resistant powder-coating
- surface with rubber mat
- 2 swivel castors
- Shelf 460 x 705 mm
- total loading capacity 300 kg
- **ccessories can be found on www.elora.de**

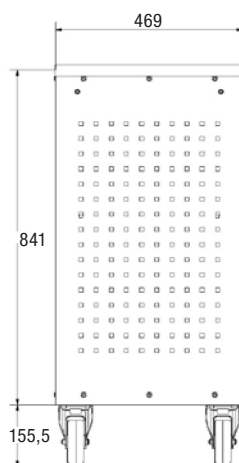
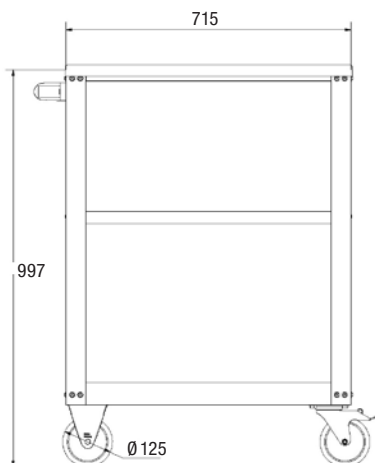

Code	Number	Height mm	Width mm	Depth mm	Loading Capacity kg	Pieces	Weight/g
1200520006100	1200-L	997	715	469	300	1	27500

1221-L

TOOL CHEST

- 3 ball bearing mounted drawers
- individual drawer locking over the entire strip (one-hand operation)
- lateral central locking of all drawers with cylinder lock
- load capacity per drawer: 45 kg
- drawers: 3 x 75 mm
- internal drawer dimensions: 573 x 410 mm
- suitable for ELORA-Nr. 1220-L und 1215-L
- suitable assortments: OMS

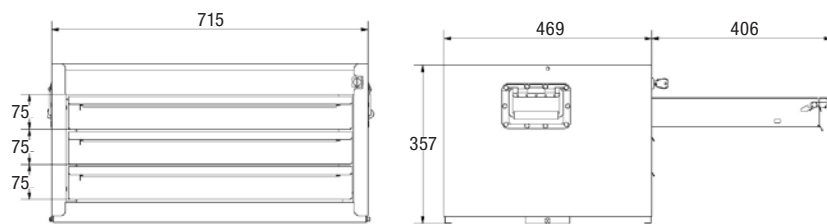

Code	Number	Height mm	Width mm	Depth mm	Loading Capacity per drawer kg	Pieces	Weight/g
1221000006100	1221-L	357	715	469	45	1	27000

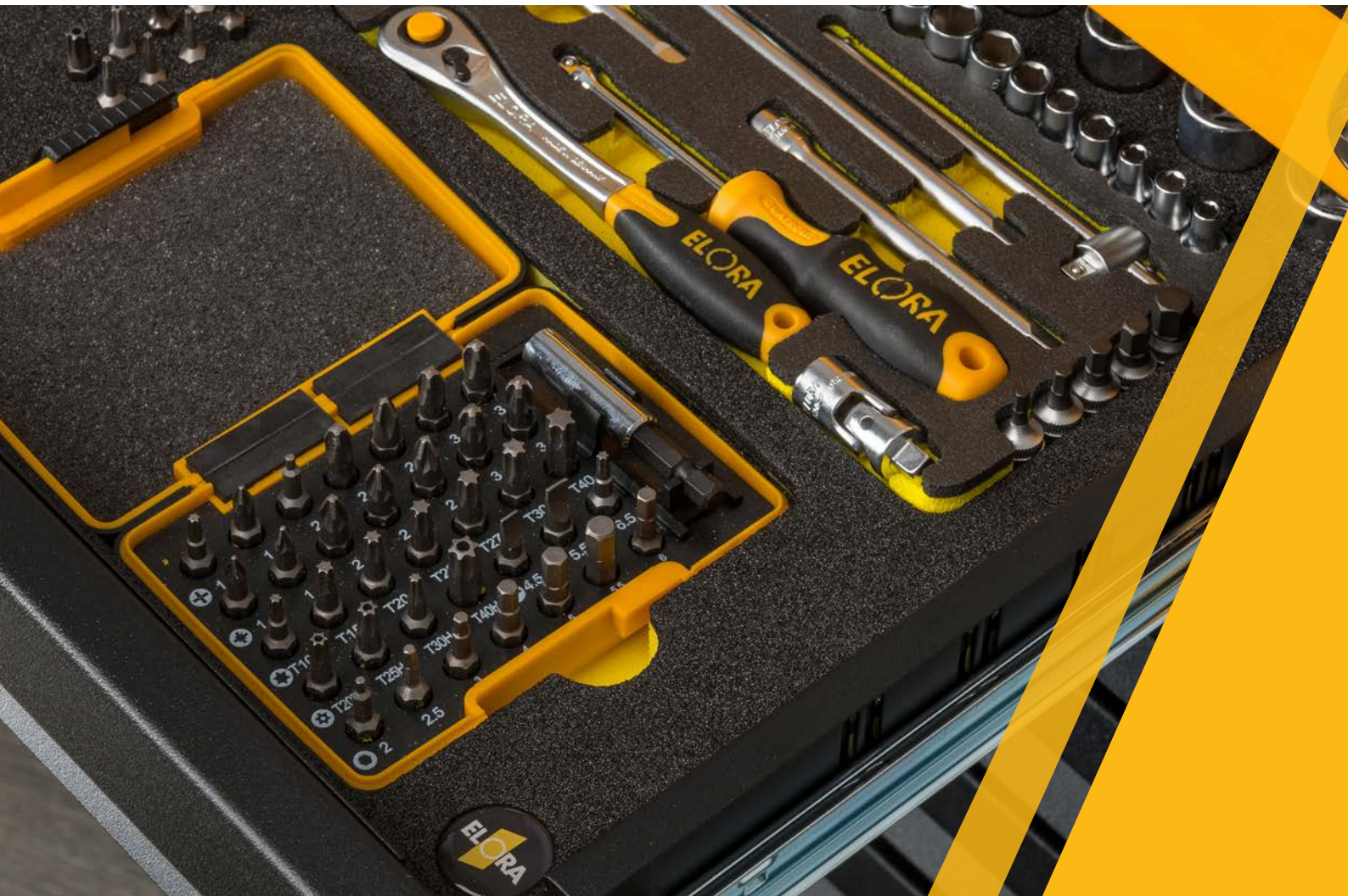

1210-L...

ROLLER TOOL CABINET BUDDY

- 7 drawers
- solid metal sheet pattern, corrosion- and scratch-resistant powder-coating
- shelf space on the top made of ABS plastic with 5 storage compartments for small parts and rim on all sides
- solid handlebar, mounting possible on both sides
- up to 6 different accessories mountable in the recessed side wall e.g. storage foldable tray for small parts ELORA No. 1210-ES, screwdriver tray for 8 screwdrivers ELORA No. 1210-SD
- 2 can holder are included
- central locking system with 2 keys
- loading capacity of each drawer 20 kg respectively 30 kg for the two lower drawers
- each drawer has a safety locking system and is 100% extractable
- drawer with ball bearing guide rails
- drawer internal measurements W 570 x D 410 mm
- drawers ELORA-black powder-coated
- can be Individually equipped with ELORA OMS modules
- total loading capacity 300 kg
- broad gauge running gear with 4 Ø 125 mm full rubber, smooth running casters, 2 swivel castors with double break function (tangential and axial)
- delivery without tools and accessories
- suitable assortments: WS and OMS
- **accessories can be found on www.elora.de**



1210-L7B

1210-L7R

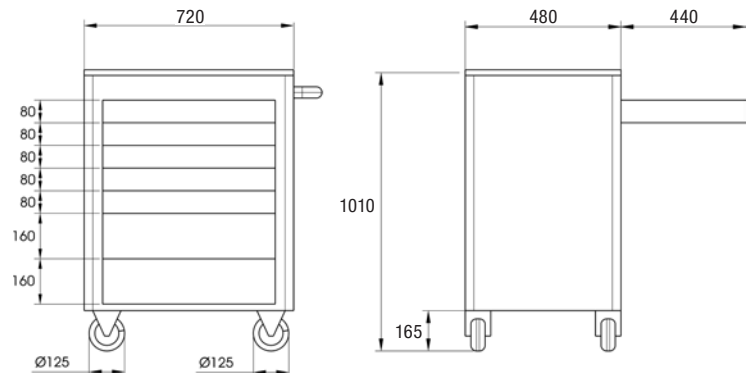

Code	Number	Height mm	Width mm	Depth mm	Loading Capacity kg	Pieces	Weight/g
121000006000	1210-L7	1010	720	480	300	1	67000
1210000016000	1210-L7R	1010	720	480	300	1	67000
1210000026000	1210-L7B	1010	720	480	300	1	67000

1811-L

WHEELED WORK BENCH

- sturdy double-walled sheet steel construction
- scratch resistant, powder coated, ELORA-yellow (RAL 1006), door/drawers black (RAL 9006)
- Storage surface made of PS (polystyrene), solvent-resistant, with integrated storage compartments
- 7 drawers with ball bearings and full-extension runners
- individual drawer locking over the whole ledge (one-hand operation)
- drawer internal measurements W 573 x D 410 mm
- drawers ELORA-black powder-coated (RAL 9005)
- central locking system with cylinder lock and 2 keys
- anti-tilt device (prevents several drawers from opening at the same time)
- load capacity per drawer: 45 kg
- door side with one shelf
- stable handle
- 2 fixed and 2 braked swivel castors
- total load capacity 450 kg
- suitable assortments: all OMS-Modules

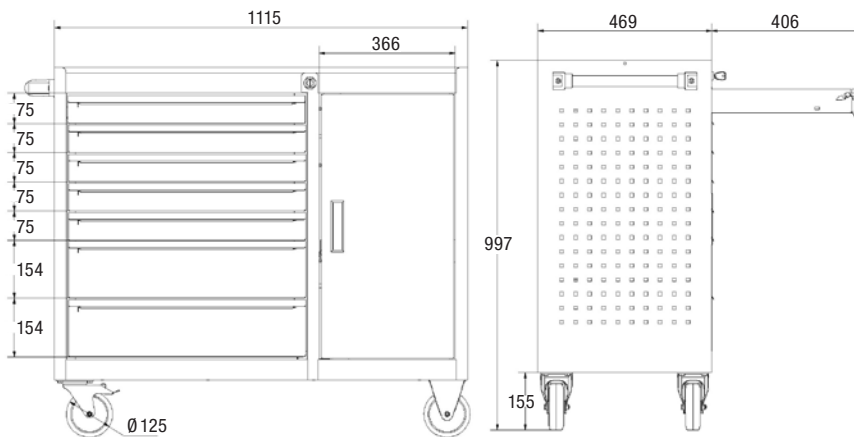

Code	Number	Width mm	Height mm	Depth mm	Pieces	Weight/g
1811500006100	1811-L	1115	997	469	1	80000

1200-RM 18

ANTI SLIP MAT

- for drawers in tool cabinets and work benches
- Length: 2m



Code	Number	Width mm	Pieces	Weight/g
1200004752000	1200-RM 18	475	1	650

1227-L

CABINET

- completely welded steel sheet construction
- 2 doors, with 4 height-adjustable shelves
- load capacity 50 kg per shelf
- doors strengthened and 3-point safety lock
- rotary handle with cylinder lock
- powder coated, ELORA-yellow (RAL 1006) doors black (RAL 9005)



Code	Number	Width mm	Height mm	Depth mm	Pieces	Weight/g
1227000006000	1227-L	950	1900	500	1	83000

1100L

TOOL CABINET

- 2 doors, with 2 drawers
- lockable with cylinder lock
- powder coated, ELORA-yellow (RAL 1006), doors black (RAL 9005)
- stable steel sheet version
- suitable assortments: all OMS-Modules



Code	Number	Width mm	Height mm	Depth mm	suitable assortments	Pieces	Weight/g
1100520001000	1100L	690	1000	290	WS-1 to 5	1	26000

1382-L1

PLASTIC TOOL CASE

- organisers for small parts integrated in the lid
- removeable tool tray
- solid single hand handle
- Polypropylene



Code	Number	Width mm	Height mm	Depth mm	Pieces	Weight/g
1382000000001	1382-L1	400	190	220	1	940

1382-L2

PLASTIC TOOL CASE

- organisers for small parts integrated in the lid
- internal tray with handle, complete with bit holder and measuring scale (cm/inch)
- solid single hand handle
- Polypropylene



Code	Number	Width mm	Height mm	Depth mm	Pieces	Weight/g
1382000000002	1382-L2	510	240	240	1	1550

1383-L

MULTI PURPOSE CASE

- ergonomic bow-type handle made of aluminium
- 2 large compartments offer storage space for tools and implements
- compartments with handy cm/inch scale
- Polypropylene



Code	Number	Width mm	Height mm	Depth mm	Pieces	Weight/g
1383000000000	1383-L	395	215	290	1	575

1815

WORK TABLE, FOLDABLE

- ▶ for mobile use, foldable to measurement H 140, W 1000, D 700 mm
- ▶ strong, multiple glued beech wood working surface
- ▶ rack made of steel tube, scratch-resistant ELORA yellow lacquered



Code	Number	Height mm	Width mm	Depth mm	Loading Capacity kg	Pieces	Weight/g
1815010001000	1815	820	1000	700	500	1	26000

800L/810L

CANTILEVER TOOL BOX WITH 5 TRAYS

- ▶ blue lacquered, to be locked with padlock ELORA-No. 256
- ▶ heavy gauge sheet steel



Code+	Number	Width mm	Height mm	Depth mm	suitable assortments	Pieces	Weight/g
0800520031000	800L	430	200	200	WS-1, 9	1	4300
0810510031000	810L	530	200	200	WS-1, 2, 3, 4, 8, 9, 10	1	5200

803L/813L

CANTILEVER TOOL BOX WITH 3 TRAYS

- ▶ blue lacquered, to be locked with padlock ELORA-No. 256
- ▶ heavy gauge sheet steel



Code	Number	Width mm	Height mm	Depth mm	suitable assortments	Pieces	Weight/g
0803510036000	803L	430	150	195	WS-1, 9	1	3300
0813510036000	813L	530	150	195	WS-1, 9	1	3600

256

PADLOCK

- ▶ for cantilever tool box ELORA-No.800L, 803L, 810L and 813L
- ▶ with steel bow 29 mm, incl. 2 keys
- ▶ Brass



Code	Number	Width mm	Pieces	Weight/g
0256000000000	256	43,8	1	80

1380-L

HARD PROTECTIVE CASE

- variable dividable floor shell
- removable cover board with 15 tool pockets
- removable tool board with 22 tool pockets on the front and back
- document compartment in the lid (A4 format)
- 2 lockable clip locks made of metal
- hinge cover
- robust aluminium frame with protection for the sharp edges
- trolley case made of dent proof black ABS material
- **delivery without tools**



Code	Number	Internal measurements WxDxH mm	External measurements WxDxH mm	max. bearing load	suitable assortments	Pieces	Weight/g
1380000000000	1380-L	460x315x169	490x365x188	25	WS-4, 6, 8, 9, 10	1	5000

1381-L

HARD PROTECTIVE TROLLEY CASE

- mobile case with telescopic handle and 2 free running rollers
- variable dividable floor shell
- removable cover board with 15 tool pockets
- removable tool board with 23 tool pockets on the front and back
- document compartment in the lid (A4 format)
- 2 lockable clip locks made of metal and additional combination lock
- hinge cover
- robust aluminium frame with protection for the sharp edges
- trolley case made of dent proof black ABS material
- **delivery without tools**



Code	Number	Internal measurements WxDxH mm	External measurements WxDxH mm	max. bearing load	Volume l	suitable assortments	Pieces	Weight/g
1381000000000	1381-L	485x375x200	515x440x225	30	36	WS-4, 6, 8, 9, 10	1	6280

1386-L

TECHNICIANS NOTEBOOK TOOL BAG

- padded lap-top compartment (17") and additional document compartment (A4 format)
- removable tool board with 8 pockets on the front and 2 rows elastic hangers on the back
- 2 small and 5 big pockets on the inside
- key ring holder
- front side 90 ° foldable
- on each side big attached pocket with hook and loop fastener
- splash proofed bottom
- adjustable strap with shoulder cushion quick fastener
- handle double fixable
- made of tear-proofed black nylon
- **delivery without tools and accessories**



01

Code	Number	Internal measurements WxDxH mm	External measurements WxDxH mm	max. bearing load	Pieces	Weight/g
1386000000000	1386-L	440x320x180	450x340x200	12	1	2380

1385-L

INSTALLATION TOOL BAG

- robust tool bag with moisture repellent bottom
- solid metal handle with padded grip
- removable cover and padded carrying strap
- outside 5 compartments with hook and loop fastener, fixation for water level
- inside 10 pockets and 8 hangers
- made of tear-proofed durable black nylon
- **delivery without tools**



Code	Number	Internal measurements WxDxH mm	External measurements WxDxH mm	max. bearing load	suitable assortments	Pieces	Weight/g
1385000000000	1385-L	400x190x240	450x250x270	12	WS-6, 9, 10	1	2820

OMS-47
MODULE-AUTOMOTIVE-TIRE AND BRAKE ASSORTMENT

- for ELORA-roller tool cabinets
- black, with yellow signal colour
- oil and grease resistant
- chemical resistant
- Width: 41,0 cm, Depth: 57,3 cm
- hard foam insert

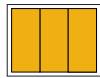
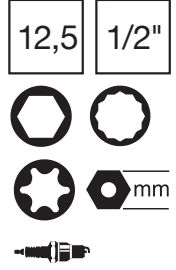

Code	Number	Contents	Pieces	Weight/g
0000414701000	OMS-47	Combination Spanner with Ring Ratchet, reversible 204-J 8, 10, 12, 13, 17, 19 mm Double-Ended Ring Spanner for outside TORX®-Screws 119TXE- 6×8, 10×12, 14×18, 20×24 mm Open Ring Spanner 121-10×11 mm Adjustable Wrench 60-12MB Spark Plug Socket 1/2" 771-LTZ 16, 18, 20,8 mm Socket Converter 770-L14, 1/2" 3/8" Impact Socket 1/2" 790LTP-17, 19, 21 mm Torque Wrench with Vernier Scale 2179-60 10-60 Nm, 2179-200 40-200 Nm Engineer's Hammer, German Pattern 1665-500 Feeler Gauge 188-13M Tyre Lever 165-300, 165-500 Brush for Brake Service 293BS Seal Flat Scraper 290-1	1	6565
0000414707000	OMS-47L	empty module	1	180

OMS-50
MODULE-SPANNER SET

- for ELORA-roller tool cabinets
- black, with yellow signal colour
- oil and grease resistant
- chemical resistant
- Width: 41,0 cm, Depth: 57,3 cm
- hard foam insert

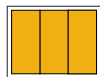
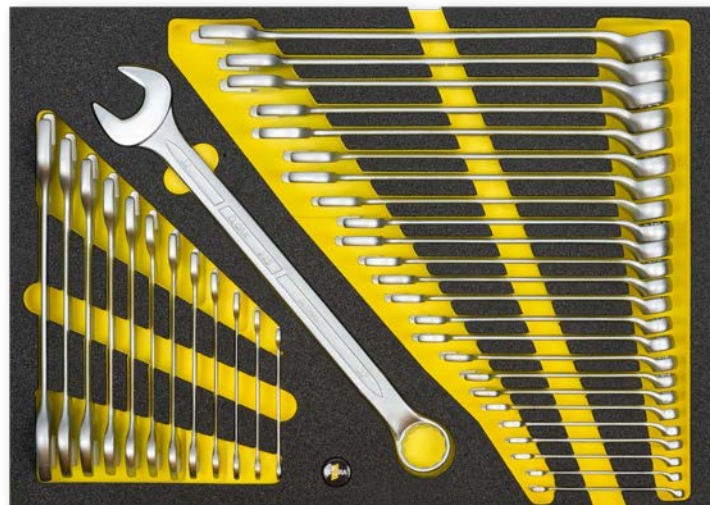

Code	Number	Contents	Pieces	Weight/g
0000415001000	OMS-50	Combination Spanners, cranked 205- 6, 7, 8, 9, 10, 11, 12, 13, 14, 15, 16, 17, 18, 19, 20, 21, 22, 23, 24, 25, 26, 27, 28, 30, 32 mm Double Open-Ended Spanners DIN 3110 100- 6×7, 8×9, 10×11, 12×13, 14×15, 16×17, 18×19, 20×22, 21×23, 24×27, 25×28, 30×32 mm	1	8010
0000415007000	OMS-50L	empty module	1	160

OMS-15

MODULE-DOUBLE OPEN ENDED SPANNER

- for ELORA-roller tool cabinets
- black, with yellow signal colour
- oil and grease resistant
- chemical resistant
- Width: 41,0 cm, Depth: 18,9 cm
- hard foam insert

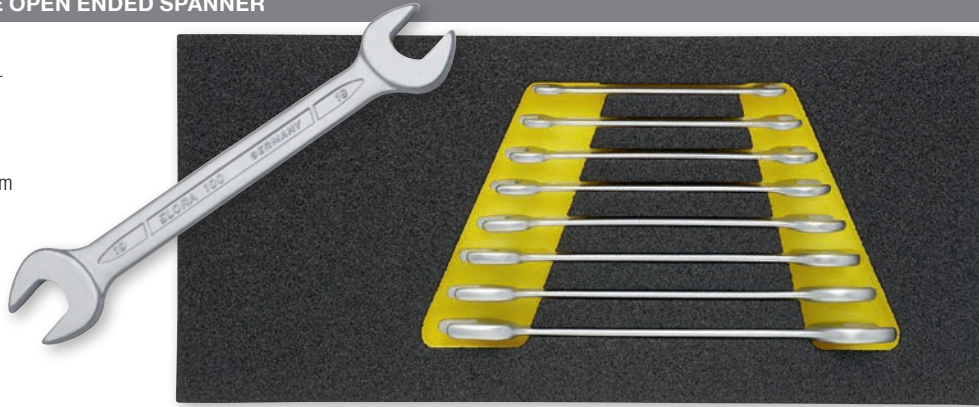

mm



Code	Number	Contents	Pieces	Weight/g
0000411501000	OMS-15	Double Open-Ended Spanners DIN 3110 100- 6×7, 8×9, 10×11, 12×13, 14×15, 16×17, 18×19, 20×22 mm	1	900
0000411507000	OMS-15L	empty module	1	80

OMS-1

MODULE-COMBINATION SPANNERS, CRANKED

- for ELORA-roller tool cabinets
- black, with yellow signal colour
- oil and grease resistant
- chemical resistant
- Width: 41,0 cm, Depth: 18,9 cm
- hard foam insert

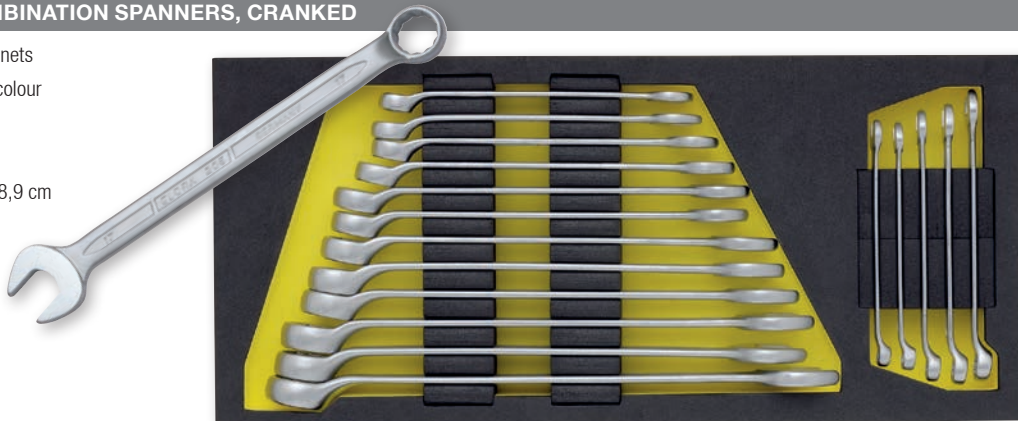

 mm

Code	Number	Contents	Pieces	Weight/g
0000410101000	OMS-1	Combination Spanners, cranked 205- 6, 7, 8, 9, 10, 11, 12, 13, 14, 15, 16, 17, 18, 19, 20, 21, 22 mm	1	1990
0000410107000	OMS-1L	empty module	1	70

OMS-51

MODULE-SPANNER SET

- for ELORA-roller tool cabinets
- black, with yellow signal colour
- oil and grease resistant
- chemical resistant
- Width: 41,0 cm, Depth: 57,3 cm
- hard foam insert

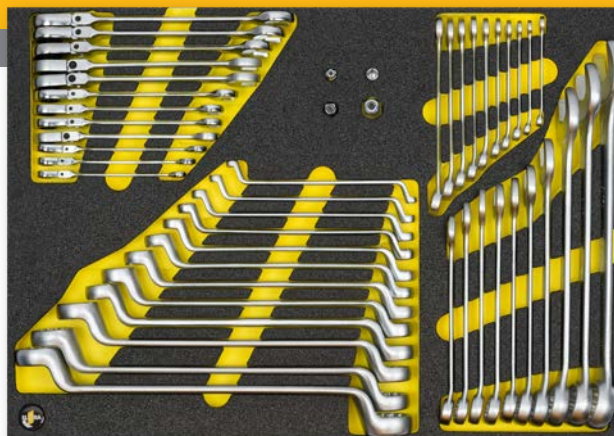

 mm

Code	Number	Contents	Pieces	Weight/g
0000415101000	OMS-51	Combination Spanners, bent 203- 6, 7, 8, 9, 10, 11, 12, 13, 14, 15, 16, 17, 18, 19, 21, 22, 24, 27, 30, 32, mm Double-Ended Ring Spanners, DIN 838 110- 6×7, 8×9, 10×11, 12×13, 14×15, 16×17, 18×19, 20×22, 21×23, 24×27, 25×28, 30×32 mm Combination Spanner with Joint-Ring Ratchet 204R- 8, 9, 10, 11, 12, 13, 14, 15, 16, 17, 18, 19 mm Adapter Drives for bits 1/4", 3/8", 1/2" und 1/4" Bit-Adaptor 118- 1, 2, 3, 4	1	8100
0000415107000	OMS-51L	empty module	1	160

OMS-9

MODULE-COMBINATION SPANNER, BENT

- for ELORA-roller tool cabinets
- black, with yellow signal colour
- oil and grease resistant
- chemical resistant
- Width: 41,0 cm, Depth: 18,9 cm
- hard foam insert

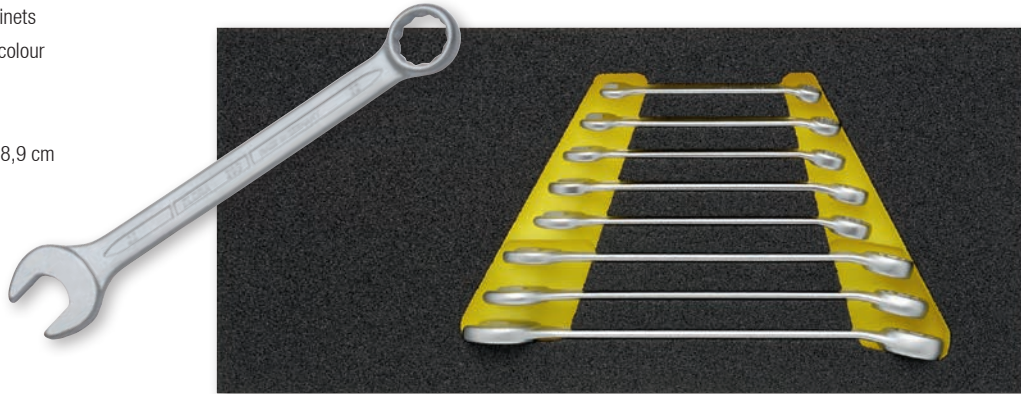

Code	Number	Contents	Pieces	Weight/g
0000410901000	OMS-9	Combination Spanners, bent 203- 8, 10, 11, 13, 14, 17, 19, 22 mm	1	690
0000410907000	OMS-9L	empty module	1	80

OMS-22

MODULE-COMBINATION SPANNER, BENT

- for ELORA-roller tool cabinets
- black, with yellow signal colour
- oil and grease resistant
- chemical resistant
- Width: 41,0 cm, Depth: 18,9 cm
- hard foam insert

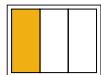
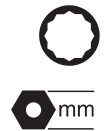

Code	Number	Contents	Pieces	Weight/g
0000412201000	OMS-22	Combination Spanners, bent 203- 24, 27, 30, 32 mm	1	1820
0000412207000	OMS-22L	empty module	1	60

OMS-30

MODULE-COMBINATION SPANNER WITH RING RATCHET

- for ELORA-roller tool cabinets
- black, with yellow signal colour
- oil and grease resistant
- chemical resistant
- Width: 41,0 cm, Depth: 18,9 cm
- hard foam insert

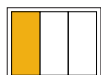

Code	Number	Contents	Pieces	Weight/g
0000413001000	OMS-30	Combination Spanners with Ring Ratchet 204- 8, 9, 10, 12, 13, 14, 17, 19 mm Adapter Drives for bits für 1/4", 3/8", 1/2" und 1/4" Bit-Adaptor 118- 1, 2, 3, 4	1	933
0000413007000	OMS-30L	empty module	1	80

OMS-33

MODULE-COMBINATION SPANNER WITH RING RATCHET, REVERSIBLE

- for ELORA-roller tool cabinets
- black, with yellow signal colour
- oil and grease resistant
- chemical resistant
- Width: 41,0 cm, Depth: 18,9 cm
- hard foam insert



Code	Number	Contents	Pieces	Weight/g
0000413301000	OMS-33	Combination Spanner with Ring Ratchet, reversible 204J- 8, 9, 10, 12, 13, 14, 17, 19 mm Adapter Drives for bits für 1/4", 3/8", 1/2" und 1/4" Bit-Adaptor 118- 1, 2, 3, 4	1	998
0000413307000	OMS-33L	empty module	1	80

OMS-32

MODULE-COMBINATION SPANNER WITH JOINT-RING RATCHET

- for ELORA-roller tool cabinets
- black, with yellow signal colour
- oil and grease resistant
- chemical resistant
- Width: 41,0 cm, Depth: 18,9 cm
- hard foam insert

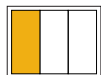

Code	Number	Contents	Pieces	Weight/g
0000413201000	OMS-32	Combination Spanner with Joint-Ring Ratchet 204R- 8, 9, 10, 12, 13, 14, 17, 19 mm Adapter Drives for bits für 1/4", 3/8", 1/2" und 1/4" Bit-Adaptor 118- 1, 2, 3, 4	1	980
0000413207000	OMS-32L	empty module	1	80

OMS-19

MODULE-DOUBLE-ENDED RING SPANNER

- for ELORA-roller tool cabinets
- black, with yellow signal colour
- oil and grease resistant
- chemical resistant
- Width: 41,0 cm, Depth: 18,9 cm
- hard foam insert

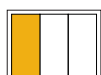
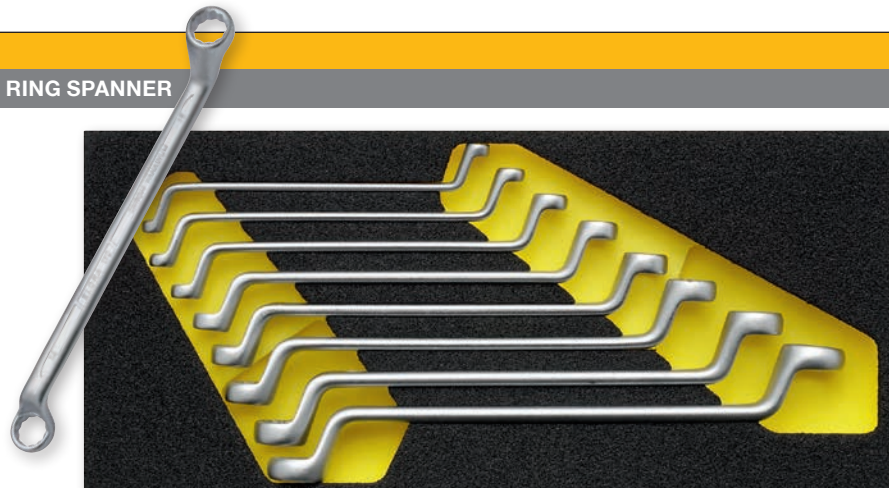

Code	Number	Contents	Pieces	Weight/g
0000411901000	OMS-19	Double-Ended Ring Spanners, DIN 838 110- 6x7, 8x9, 10x11, 12x13, 14x15, 16x17, 18x19, 20x22 mm	1	1350
0000411907000	OMS-19L	empty module	1	70

OMS-28

MODULE-RATCHET RING SPANNER

- for ELORA-roller tool cabinets
- black, with yellow signal colour
- oil and grease resistant
- chemical resistant
- Width: 41,0 cm, Depth: 18,9 cm
- hard foam insert

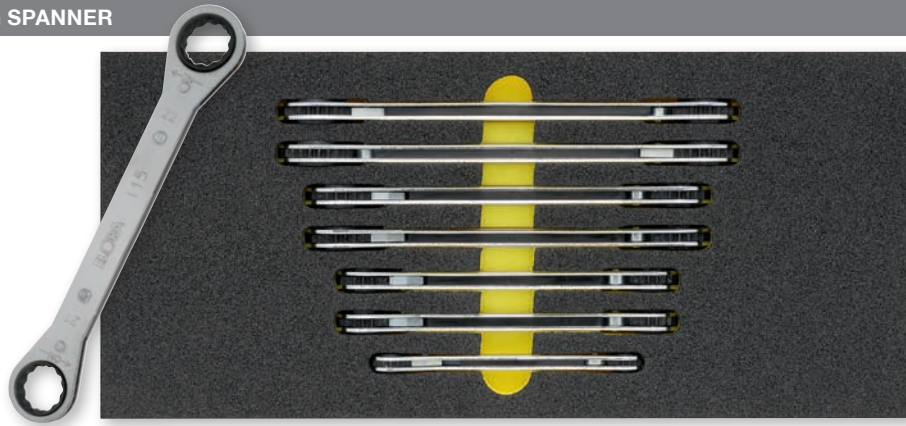

Code	Number	Contents	Pieces	Weight/g
0000412801000	OMS-28	Ratchet Ring Spanners, straight 115 - 8x9, 10x11, 12x13, 14x15, 16x17, 18x19, 21x22 mm	1	1330
0000412807000	OMS-28L	empty module	1	80

OMS-29

MODULE-RATCHET RING SPANNERS, BENT

- for ELORA-roller tool cabinets
- black, with yellow signal colour
- oil and grease resistant
- chemical resistant
- Width: 41,0 cm, Depth: 18,9 cm
- hard foam insert

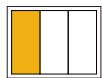
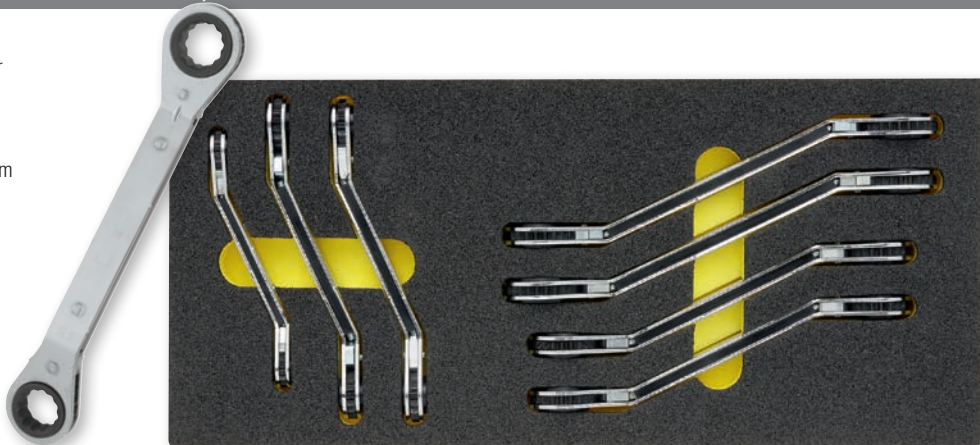

Code	Number	Contents	Pieces	Weight/g
0000412901000	OMS-29	Ratchet Ring Spanners, bent 115G - 8x9, 10x11, 12x13, 14x15, 16x17, 18x19, 21x22 mm	1	1340
0000412907000	OMS-29L	empty module	1	80

OMS-31

MODULE-FLARE NUT OPEN ENDED RING SPANNER

- for ELORA-roller tool cabinets
- black, with yellow signal colour
- oil and grease resistant
- chemical resistant
- Width: 41,0 cm, Depth: 18,9 cm
- hard foam insert

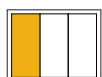
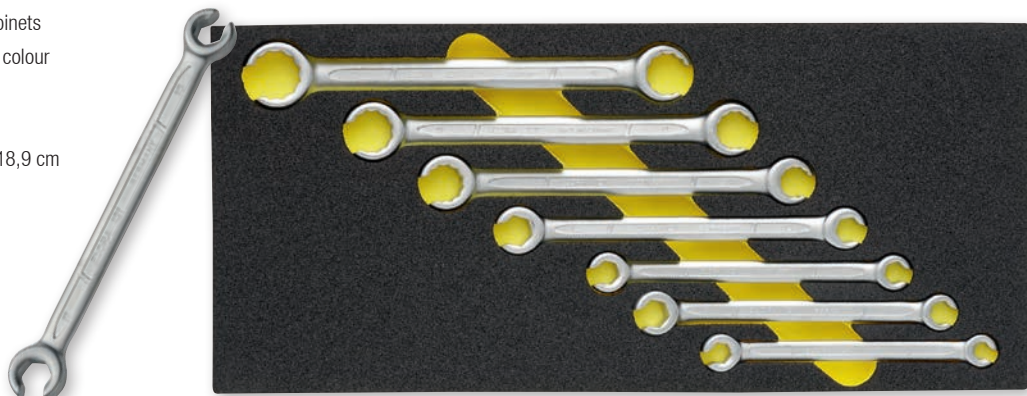

Code	Number	Contents	Pieces	Weight/g
0000413101000	OMS-31	Ended Ring Spanners for flare nuts 121 - 8x10, 10x11, 11x13, 12x14, 14x17, 17x19, 19x22 mm	1	850
0000413107000	OMS-31L	empty module	1	80

OMS-46

MODULE-SOCKET SET 1/4" AND 1/2"

- for ELORA-roller tool cabinets
- black, with yellow signal colour
- oil and grease resistant
- chemical resistant
- Width: 41,0 cm, Depth: 57,3 cm
- hard foam insert

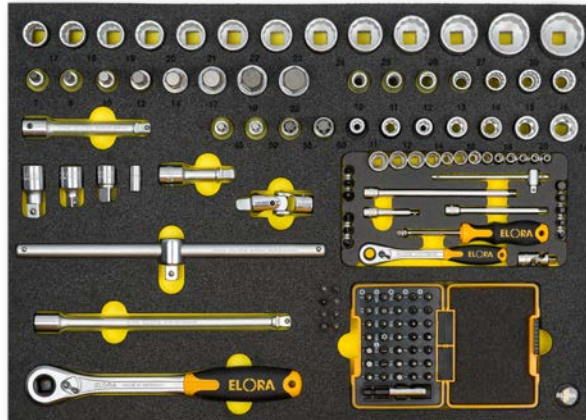

6,3 12,5

1/4" 1/2"

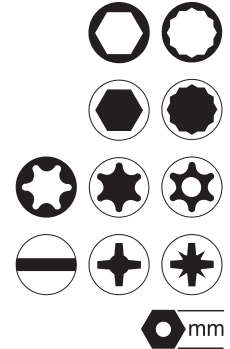

mm

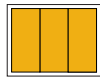

Code	Number	Contents	Pieces	Weight/g
0000414601000	OMS-46	1440-MU Socket Set 1/4", 30 pcs. ○ ● ⊖ ⊕ Bitbox 1/4", 36 pcs. ⊖ ⊕ ⊕ ⊕ ⊕ ⊕ Screwdriver Bit 1/4" for Inside TORX® Screws ☆ 3050-TX 6, 7, 8, TX 9, TX 10 Screwdriver Bit 1/4" for Inside TORX® Safety Screws ☆ 3070-TTX 10, 15, 27 Socket Converter 1/4" 1450-16, 1/4" ○ 1/4" ○ Bihexagon Sockets 1/2" ○ 770-LM 10, 11, 12, 13, 14, 15, 16, 17, 18, 19, 20, 21, 22, 23, 24, 25, 26, 27, 30, 32 mm Reversible Ratchet 1/2" 770-L1D Sliding T-Bar 1/2" 770-L3 Extension Bar 1/2" 50 mm 770-L35 Extension Bar 1/2", swivelling 75 mm 770-L4V Extension Bar 1/2", swivelling 125 mm 770-L5V Extension Bar 1/2", swivelling 250 mm 770-L6V Universal Joint 1/2" 770-L7 Socket Converter 1/2" 770-L13, 3/8" ■ 1/2" ○ Socket Converter 1/2" 770-L14, 1/2" ■ 3/8" ○ Screwdriver Sockets 1/2" for inside Hexagon Screws ● 3210-IN 7, IN 8, IN 10, IN 12, IN 14, IN 17, IN 19, IN 22 Screwdriver Sockets 1/2" for Inside TORX® Screws ☆ 3245-TX 45, TX 50, TX 55, TX 60 Sockets 1/2" for Outside TORX® Screws ☆ 770-LTXE 11, 12, 14, 16, 18, 20, 24 mm	1	6540
0000414607000	OMS-46L	empty module	1	180

OMS-52

MODULE-SOCKET SET, DEEP 1/4" AND 1/2"

- for ELORA-roller tool cabinets
- black, with yellow signal colour
- oil and grease resistant
- chemical resistant
- Width: 41,0 cm, Depth: 57,3 cm
- hard foam insert

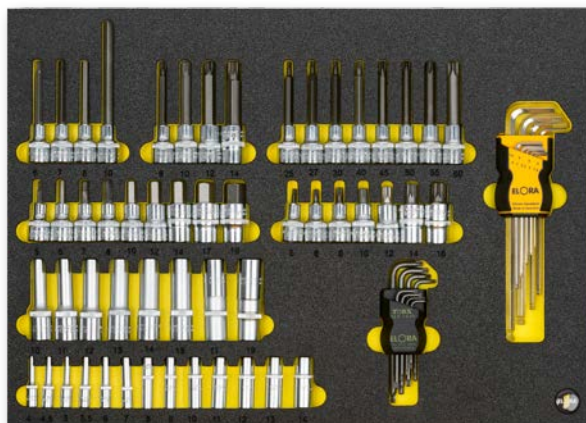

6,3 12,5

1/4" 1/2"

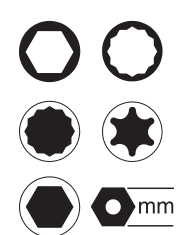

mm

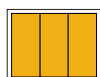

Code	Number	Contents	Pieces	Weight/g
0000415201000	OMS-52	Hexagon Sockets, extra deep 1/4" ○ 1455-T 4, 4,5, 5, 5,5, 6, 7, 8, 9, 10, 11, 12, 13, 14 mm Hexagon Sockets, extra deep 1/2" ○ 771-LT 10, 11, 12, 13, 14, 15, 17, 19 mm Screwdriver Sockets 1/2" for inside Hexagon Screws ● 3210-IN 5, IN 6, IN 7, IN 8, IN 10, IN 12, IN 14, IN 17, IN 19 Screwdriver Sockets 1/2", long for inside Hexagon Screws ● 3210-INL 6x100, INL 7x100, INL 8x100, INL 10x140 Screwdriver Sockets 1/2", long for inside-TORX®-Screws ☆ 3245-TXL 25, TXL 27, TXL 30, TXL 40, TXL 45, TXL 50, TXL 55, TXL 60 Screwdriver Sockets 1/2" for inside multi-point B & S and XZN ● 3230-XZN 5, XZN 6, XZN 8, XZN 10, XZN 12, XZN 14, XZN 16 Screwdriver Sockets 1/2", long for inside multi-point B & S and XZN ● 3230-XZNL 8x100, XZNL 10x100, XZNL 12x100, XZNL 14x100 159SKU Ball End Hexagon Key Set, extra long, 1,5-10 mm ● 162S-TXKU TORX®-Ball End Key Set, TX 9-40 ☆	1	5370
0000415207000	OMS-52L	empty module	1	160

OMS-2

MODULE-SOCKET SET 1/4"

- for ELORA-roller tool cabinets
- black, with yellow signal colour
- oil and grease resistant
- chemical resistant
- Width: 41,0 cm, Depth: 18,9 cm
- hard foam insert



6,3 1/4"

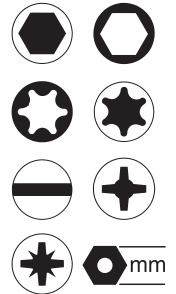

Code	Number	Contents		Pieces	Weight/g
0000410201000	OMS-2	Hexagon Sockets 1/4" ○ 1455-4, 4,5, 5, 5,5, 6, 7, 8, 9, 10,11, 12, 13, 14 mm Screwdriver Sockets for plain slotted screws ⊖ 1455-IS 0,8x4, 1,0x5,5, 1,6x8,0 mm Screwdriver Sockets for cross slotted screws ⊕ 1455-PH 1, PH 2, PH 3, PH 4 Screwdriver Sockets for cross slotted screws ⊕ 1455-PZ 1, PZ 2 Screwdriver Sockets for inside hexagon screws ● 1455-IN 3, 4, 5, 6, 8 mm Sockets for outside TORX® screws ⊕ 1455-TXE 4, 5, 6, 7, 8, 10,11	Screwdriver Sockets for inside TORX® screws ⊕ 3243-TX 8, 10, 15, 20, 25, 27, 30,40 Reversible Ratchets 1450-1D Spinner Handle 1450-3 Sliding T-Bar 1450-4 Universal Joint 1450-8 Extension Bar 50 mm 1450-11 Extension Bar 150 mm 1450-12 Socket Converter 1/4" 1450-15, 3/8" ■ 1/4" ○ 159SKU Ball End Hexagon Key Set, extra long, 1,5-10 mm ●	1	1480
0000410207000	OSM-2L	empty module		1	80

OMS-49

MODULE-SOCKET SET 3/8"

- for ELORA-roller tool cabinets
- black, with yellow signal colour
- oil and grease resistant
- chemical resistant
- Width: 41,0 cm, Depth: 37,7 cm
- hard foam insert

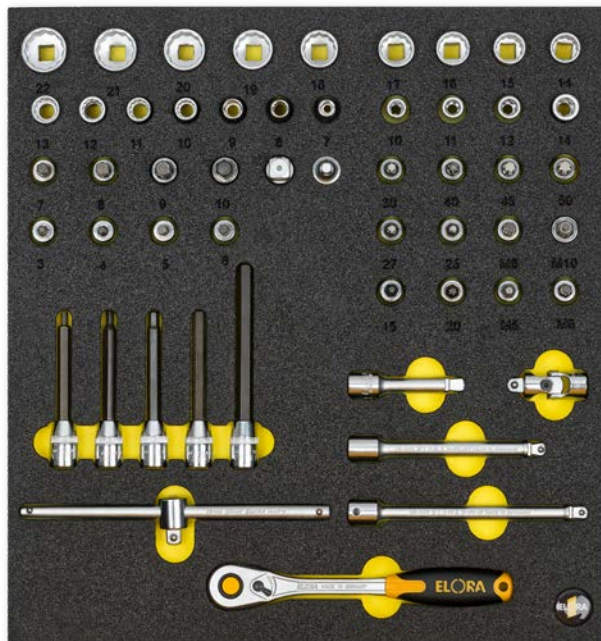

10 3/8"

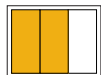
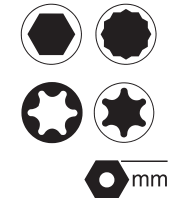

Code	Number	Contents		Pieces	Weight/g
0000414901000	OMS-49	Bi-Hexagon Sockets ○ 870- 7, 8, 9, 10, 11, 12, 13, 14, 15, 16, 17, 18, 19, 20, 21, 22 mm Screwdriver Sockets ● 3510-IN 3, 4, 5, 6, 7, 8, 9, 10 Screwdriver Sockets long for inside hexagon screws ● 3510-INL 4x100, 5x100, 6x100, 8x100, 10x130 Screwdriver Sockets for inside-TORX® screws ⊕ 3244-TX 15, 20, 25, 27, 30, 40, 45, 50 Screwdriver Sockets for inside multi-point B & S and XZN screws ● 3530-XZN 5, 6, 8, 10	Screwdriver Sockets for Outside-TORX® screws ⊕ 870-TXE 10, 11, 12, 14 Reversible Ratchet 870-1D Sliding T-Bar 870-8 Universal Joint 870-9 Extension Bar, swivelling 50 mm 870-3V Extension Bar, swivelling 125 mm 870-35V Extension Bar, swivelling 150 mm 870-4V Socket Converter 870-10, 1/4" ■ 3/8" ○ Socket Converter 770-L14, 1/2" ■ 3/8" ○	1	3165
0000414907000	OSM-49L	empty module		1	160

OMS-34/21

MODULE - SOCKET SET 3/8"

- for ELORA-roller tool cabinets
- black, with yellow signal colour
- oil and grease resistant
- chemical resistant
- Width: 41,0 cm, Depth: 18,9 cm
- hard foam insert

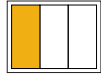
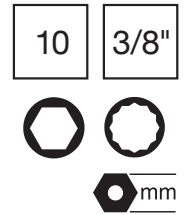

Code	Number	Contents	Pieces	Weight/g
0000413401000	OMS-34	Bi-Hexagon Sockets 870- 7, 8, 9, 10, 11, 12, 13, 14, 15, 16, 17, 18, 19, 20, 21, 22 mm ○ Reversible Ratchet 870-1D Extension Bar 125 mm 870-35 Extension Bar 250 mm 870-55 Universal Joint 870-9	1	1340
0000412101000	OMS-21	same as OMS-34, but all sockets in hexagon pattern ○	1	1340
0000412107000	OMS-21/34L	empty module	1	80

OMS-3/4

MODULE-SOCKET SET 1/2"

- for ELORA-roller tool cabinets
- black, with yellow signal colour
- oil and grease resistant
- chemical resistant
- Width: 41,0 cm, Depth: 18,9 cm
- hard foam insert

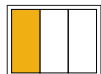
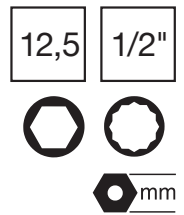

Code	Number	Contents	Pieces	Weight/g
0000410301000	OMS-3	Bi-Hexagon Sockets 770-LM 8, 9, 10, 11, 12, 13, 14, 15, 16, 17, 18,19, 20, 21, 22, 24, 25, 27, 30, 32 mm ○ Reversible Ratchet 770-L1D Sliding T-Bar 770-L3 Extension Bar 125 mm 770-L5 Extension Bar 250 mm 770-L6 Universal Joint 770-L7	1	3420
0000410401000	OMS-4	same as OMS-3, but all sockets in hexagon pattern ○	1	3400
0000410307000	OMS-3/4L	empty module	1	80

OMS-35/25

MODULE-SOCKET SET 3/4"

- for ELORA-roller tool cabinets
- black, with yellow signal colour
- oil and grease resistant
- chemical resistant
- Width: 41,0 cm, Depth: 37,7 cm
- hard foam insert

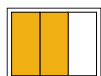
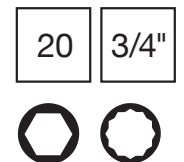

Code	Number	Contents	Pieces	Weight/g
0000413501000	OMS-35	Bi-Hexagon Sockets 770-S 22, 24, 27, 30, 32, 36, 38, 41, 46, 50 mm ○ Reversible Ratchet Head 770-S1K Extension Bar 200 mm 770-S4 Extension Bar 400 mm 770-S5 Tommy Bar 770-S7 Sliding Head 770-S13	1	9280
0000412501000	OMS-25	same as OMS-35, but all sockets in hexagon pattern ○	1	9280
0000412507000	OMS-25/35L	empty module	1	125

OMS-24

MODULE-IMPACT-SOCKET SET 1/2"

- for ELORA-roller tool cabinets
- black, with yellow signal colour
- oil and grease resistant
- chemical resistant
- Width: 41,0 cm, Depth: 18,9 cm
- hard foam insert

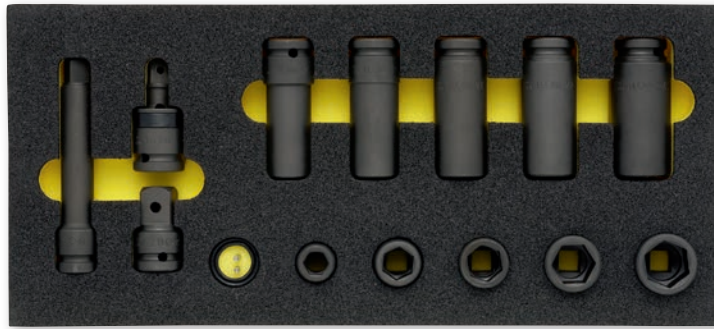

12,5

1/2"



Code	Number	Contents	Pieces	Weight/g
0000412401000	OMS-24	Impact Sockets 790-13, 17, 19, 22, 24 mm ○ Impact Sockets extra deep 790LT-17, 19, 21, 22, 24 mm ○ Impact Extension Bar 7901-125 Impact Adaptor 7902-3/4, 3/4" ■ 1/2" ○ Impact Universal Joint 795 -1/2 Impact Locking pins 7903-20, 25 Impact Locking rings 7904-20, 24	1	2900
0000412407000	OMS-24L	empty module	1	80

OMS-23

MODULE-IMPACT-SOCKET SET 3/4"

- for ELORA-roller tool cabinets
- black, with yellow signal colour
- oil and grease resistant
- chemical resistant
- Width: 41,0 cm, Depth: 37,7 cm
- hard foam insert



20

3/4"

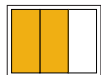
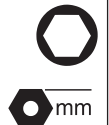

Code	Number	Contents	Pieces	Weight/g
0000412301000	OMS-23	Impact Sockets 791-24, 27, 30, 32, 36 mm ○ Impact Sockets extra deep 791LT-17, 19, 24, 27, 30, 32 mm ○ Impact Adaptor 7912-1/2, 1/2" ■ 3/4" ○ Impact Universal Joint 795 -3/4 Impact Locking pins 7913-29, 37 Impact Locking rings 7914-28, 36	1	7780
0000412307000	OMS-23L	empty module	1	125

OMS-18

MODULE-TORX®-TOOLS

- for ELORA-roller tool cabinets
- black, with yellow signal colour
- oil and grease resistant
- chemical resistant
- Width: 41,0 cm, Depth: 18,9 cm
- hard foam insert



12,5

1/2"



Code	Number	Contents	Pieces	Weight/g
0000411801000	OMS-18	Screwdriver Sockets for inside TORX® screws 3245 TX 20, 25, 27, 30, 40, 45, 50, 55, 60 ☉ TORX®-Ball End Key Set 162S-TXKU 9, 10, 15, 20, 25, 27, 30, 40 ✪	1	980
0000411807000	OMS-18L	empty module	1	80

OMS-26

MODULE HEXAGON KEY SET

- for ELORA-roller tool cabinets
- black, with yellow signal colour
- oil and grease resistant
- chemical resistant
- Width: 41,0 cm, Depth: 18,9 cm
- hard foam insert

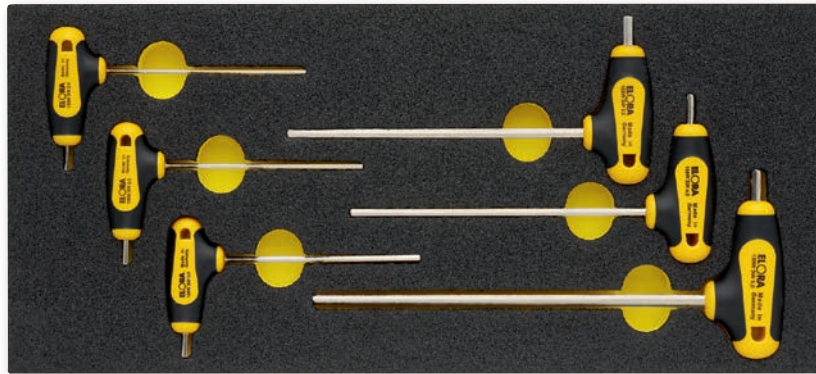

Code	Number	Contents	Pieces	Weight/g
0000412601000	OMS-26	Hexagon Key with T-Handle ● 159W-2, 2,5, 3, 4, 5, 6	1	340
0000412607000	OMS-26L	empty module	1	80

OMS-27

MODUL-TORX®-KEY SET WITH T-HANDLE

- for ELORA-roller tool cabinets
- black, with yellow signal colour
- oil and grease resistant
- chemical resistant
- Width: 41,0 cm, Depth: 18,9 cm
- hard foam insert

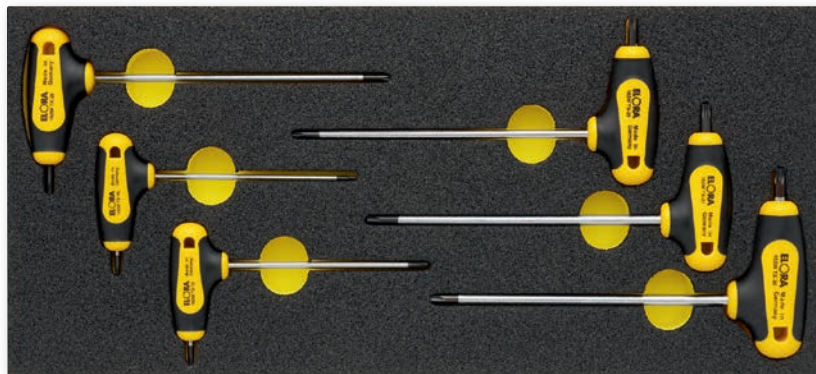

Code	Number	Contents	Pieces	Weight/g
0000412701000	OMS-27	TORX®-Key with T-Handle ★ 162WTX-10, 15, 20, 25, 27, 30	1	360
0000412707000	OMS-27L	empty module	1	80

OMS-48

MODULE-SCREWDRIVERS

- for ELORA-roller tool cabinets
- black, with yellow signal colour
- oil and grease resistant
- chemical resistant
- Width: 41,0 cm, Depth: 57,3 cm
- hard foam insert

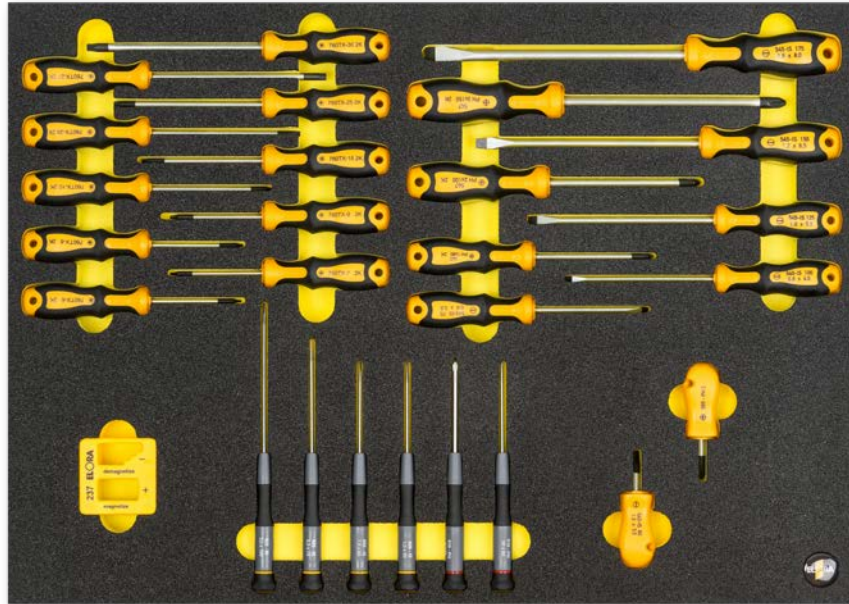

Code	Number	Contents	Pieces	Weight/g
0000414801000	OMS-48	QUATROLIT®-2C-Screwdriver for plain slotted screws 545-IS 75 (0,6x3,5) 100 (0,8x4,0) 125 (1,0x5,5) 150 (1,2x6,5) 175 (1,6x8,0) Screwdriver for plain slotted screws, short version 543-IS 60 (1,0x5,5) Screwdriver for cross slotted screws, short version 555-PH 2 QUATROLIT®-2C-Screwdriver for cross slotted screws 547-PH 1, 2, 3 Electronic Screwdriver for plain slotted screws 600-IS 1,5x60, 1,8x60, 2,5x75, 3,0x100 Electronic Screwdriver for cross slotted screws 610-PH 00, PH 0 Screwdriver for Inside TORX® screws 760TX-6, 7, 8, 9, 10, 15, 20, 25, 27, 30 Magnetizer-Demagnetizer 237	1	1410
0000414807000	OMS-48L	empty module	1	160

OMS-11

MODULE-QUATROLIT®-2C-SCREWDRIVERS

- for ELORA-roller tool cabinets
- black, with yellow signal colour
- oil and grease resistant
- chemical resistant
- Width: 41,0 cm, Depth: 18,9 cm
- hard foam insert

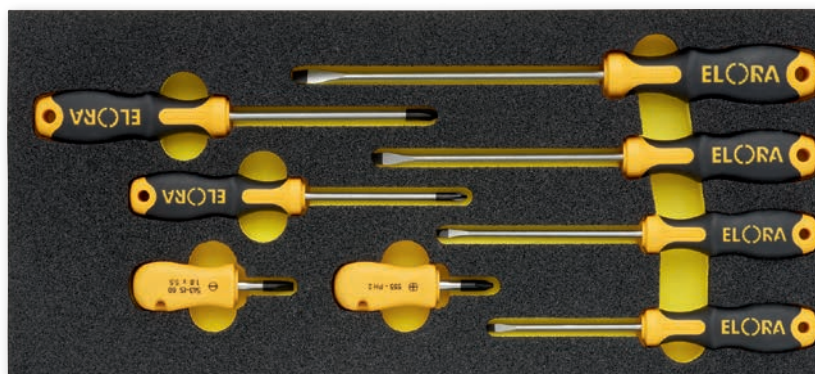

Code	Number	Contents	Pieces	Weight/g
0000411101000	OMS-11	QUATROLIT®-2C-Screwdriver for plain slotted screws 545-IS 75 (0,6x3,5) 100 (0,8x4,0) 125 (1,0x5,5) 150 (1,2x6,5) QUATROLIT®-2C-Screwdriver for cross slotted screws 547-PH 1, 2 Screwdriver for plain slotted screws, short version 543-IS 45 (0,6x3,5) Screwdriver for cross slotted screws, short version 555-PH 1	1	485
0000411107000	OMS-11/38L	empty module	1	80

OMS-6

MODULE-QUATROLIT®-2C-SCREWDRIVERS

- for ELORA-roller tool cabinets
- black, with yellow signal colour
- oil and grease resistant
- chemical resistant
- Width: 41,0 cm, Depth: 18,9 cm
- hard foam insert

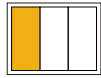

Code	Number	Contents	Pieces	Weight/g
0000410601000	OMS-6	QUATROLIT®-2C Screwdriver for plain slotted screws 539-IS 90 (0,8x4,0) 100 (1,0x5,5) 125 (1,2x6,5) 150 (1,2x8,0) 649-IS 75 (0,5x3,0) ⊖ QUATROLIT®-2C Screwdriver for cross slotted screws 559-PH 1, 2, 3 ⊕ Screwdriver for plain slotted screws, short version 543-IS 60 (1,0x5,5) ⊖ Screwdriver for cross slotted screws, short version 555-PH 1 ⊕	1	900
0000410607000	OMS-36L/37L	empty module	1	80

OMS-7

MODULE-QUATROLIT®-2C-SCREWDRIVERS

- for ELORA-roller tool cabinets
- black, with yellow signal colour
- oil and grease resistant
- chemical resistant
- Width: 41,0 cm, Depth: 18,9 cm
- hard foam insert



Code	Number	Contents	Pieces	Weight/g
0000410701000	OMS-7	QUATROLIT®-2C-Screwdriver for plain slotted screws 539-IS 90 (0,8x4,0) 100 (1,0x5,5) 125 (1,2x6,5) 150 (1,2x8,0) ⊖ QUATROLIT®-2C-Screwdriver for cross slotted screws 559-PH 1, 2, 3 ⊕ Screwdriver for plain slotted screws, short version 543-IS 60 (1,0x5,5) ⊖ Screwdriver for cross slotted screws, short version 555-PH 2 ⊕	1	900
0000410607000	OMS-36L/37L	empty module	1	80

OMS-36

MODULE-QUATROLIT®-2C-SCREWDRIVERS

- for ELORA-roller tool cabinets
- black, with yellow signal colour
- oil and grease resistant
- chemical resistant
- Width: 41,0 cm, Depth: 18,9 cm
- hard foam insert

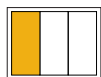
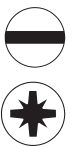

Code	Number	Contents	Pieces	Weight/g
0000413601000	OMS-36	QUATROLIT®-2C-Screwdriver for plain slotted screws 539-IS 90 (0,8x4,0) 100 (1,0x5,5) 125 (1,2x6,5) 150 (1,2x8,0) ⊖ QUATROLIT®-2C-Screwdriver for plain slotted screws 545-IS 75 (0,6x3,5) QUATROLIT®-2C-Screwdriver for cross slotted screws 569-PZ 1, 2, 3 ⊕ Screwdriver for plain slotted screws, short version 543-IS 60 (1,0x5,5) ⊖ Screwdriver for cross slotted screws, short version 554-PZ 2 ⊕	1	900
0000410607000	OMS-36L/37L	empty module	1	80

OMS-37

MODULE-QUATROLIT®-2C-SCREWDRIVERS

- ▶ for ELORA-roller tool cabinets
- ▶ black, with yellow signal colour
- ▶ oil and grease resistant
- ▶ chemical resistant
- ▶ Width: 41,0 cm, Depth: 18,9 cm
- ▶ hard foam insert

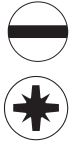

Code	Number	Contents	Pieces	Weight/g
0000413701000	OMS-37	QUATROLIT®-2C-Screwdriver for plain slotted screws 539-IS 75 (0,6x3,5) 90 (0,8x4,0) 100 (1,0x5,5) 125 (1,2x6,5) 150 (1,2x8,0) ⇐ QUATROLIT®-2C-Screwdriver for cross slotted screws 569-PZ 1, 2, 3 ⇨ Screwdriver for plain slotted screws, short version 543-IS 60 (1,0x5,5) ⇐ Screwdriver for cross slotted screws, short version 554-PZ 2 ⇨	1	900
0000410607000	OMS-36L/37L	empty module	1	80

OMS-38

MODULE-QUATROLIT®-2C-SCREWDRIVERS

- ▶ for ELORA-roller tool cabinets
- ▶ black, with yellow signal colour
- ▶ oil and grease resistant
- ▶ chemical resistant
- ▶ Width: 41,0 cm, Depth: 18,9 cm
- ▶ hard foam insert

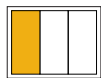
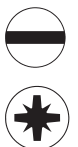
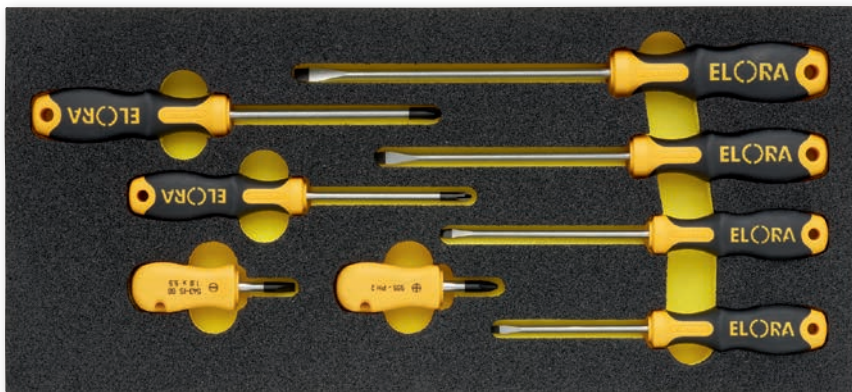

Code	Number	Contents	Pieces	Weight/g
0000413801000	OMS-38	QUATROLIT®-2C-Screwdriver for plain slotted screws 545-IS 75 (0,6x3,5) 100 (0,8x4,0) 125 (1,0x5,5) 150 (1,2x6,5) ⇐ QUATROLIT®-2C-Screwdriver for cross slotted screws 549-PZ 1, 2 ⇨ Screwdriver for plain slotted screws, short version 543-IS 45 (0,6x3,5) ⇐ Screwdriver for cross slotted screws, short version 554-PZ 1 ⇨	1	470
0000411107000	OMS-11/38L	empty module	1	80

OMS-16

MODULE ENGINEER SCREWDRIVERS

- ▶ for ELORA-roller tool cabinets
- ▶ black, with yellow signal colour
- ▶ oil and grease resistant
- ▶ chemical resistant
- ▶ Width: 41,0 cm, Depth: 18,9 cm
- ▶ hard foam insert

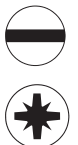
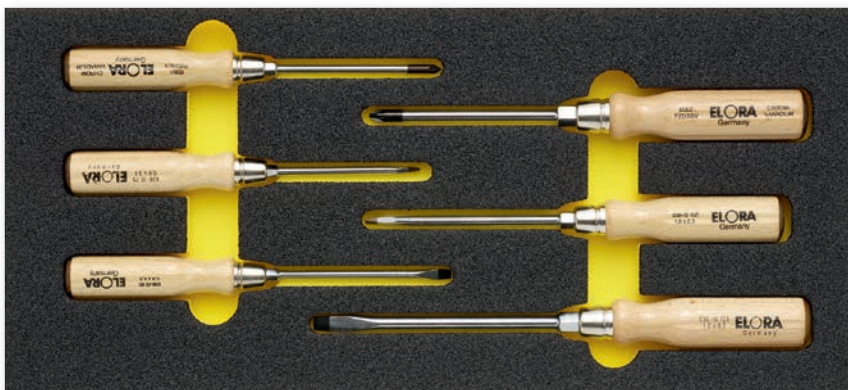

Code	Number	Contents	Pieces	Weight/g
0000411601000	OMS-16	Screwdriver for plain slotted screws with wooden handle ⇐ 636-IS 75 (0,6x3,5) 90 (0,8x4,5) 100 (1,0x5,5) 125 (1,2x6,5) Screwdriver for cross slotted screws with wooden handle ⇨ 658-PZ 1, 2	1	460
0000411607000	OMS-16L	empty module	1	80

OMS-17

MODULE ENGINEER SCREWDRIVERS

- for ELORA-roller tool cabinets
- black, with yellow signal colour
- oil and grease resistant
- chemical resistant
- Width: 41,0 cm, Depth: 18,9 cm
- hard foam insert

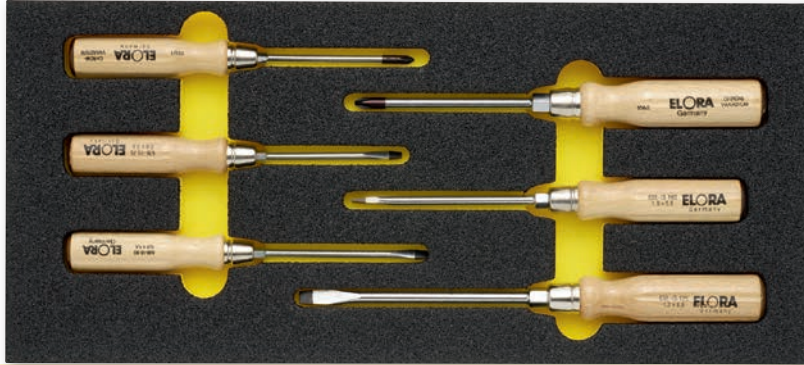

Code	Number	Contents	Pieces	Weight/g
0000411701000	OMS-17	Screwdriver for plain slotted screws with wooden handle 636-IS 75 (0,6x3,5) 90 (0,8x4,5) 100 (1,0x5,5) 125 (1,2x6,5) Screwdriver for cross slotted screws with wooden handle 656-PH 1, 2	1	460
0000411707000	OMS-17L	empty module	1	80

OMS-43

MODULE VDE SCREWDRIVERS

- for ELORA-roller tool cabinets
- black, with yellow signal colour
- oil and grease resistant
- chemical resistant
- Width: 41,0 cm, Depth: 18,9 cm
- hard foam insert

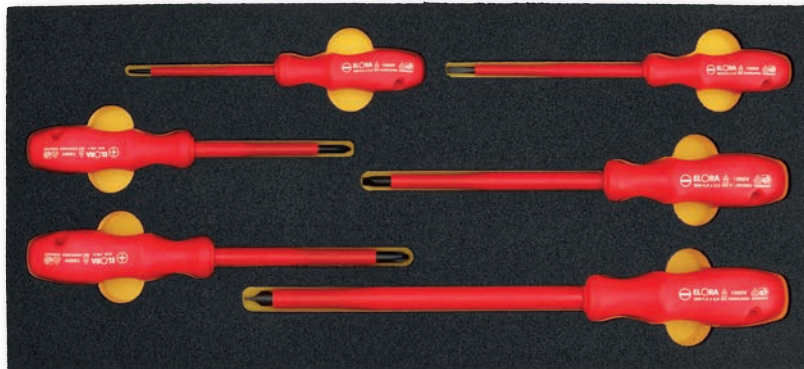

Code	Number	Contents	Pieces	Weight/g
0000414301000	OMS-43	VDE Screwdriver for plain slotted screws 900-IS 75 (0,4x2,5) 106 (0,6x3,5) 12510 (1,0x5,5) 175 (1,2x8,0) VDE Screwdriver for cross slotted screws 910-PH 1, 2	1	460
0000414307000	OMS-43L	empty module	1	80

OMS-10

MODULE-PLIERS

- for ELORA-roller tool cabinets
- black, with yellow signal colour
- oil and grease resistant
- chemical resistant
- Width: 41,0 cm, Depth: 18,9 cm
- hard foam insert

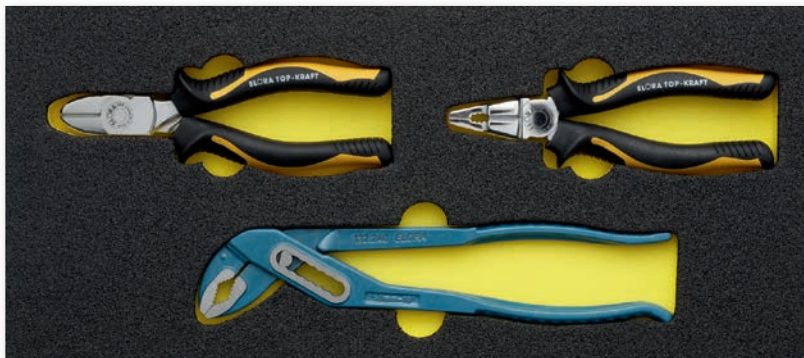

Code	Number	Contents	Pieces	Weight/g
0000411001000	OMS-10	Combination Plier, German pattern 495BI-165 Diagonal Cutter 492BI-160 Waterpump Plier 132-240	1	845
0000411007000	OMS-10L	empty module	1	80

OMS-53

MODULE-PLIERS

- for ELORA-roller tool cabinets
- black, with yellow signal colour
- oil and grease resistant
- chemical resistant
- Width: 41,0 cm, Depth: 57,3 cm
- hard foam insert



Code	Number	Contents	Pieces	Weight/g
0000415301000	OMS-53	Grip Plier with Wire Cutter, for round and flat material 500-250 Universal Scissors, straight 498-1 Heavy Duty Side Cutter 490BI-165 Snipe Nose Plier with side cutter, straight pattern Form 470BI-165 Combination Plier, German pattern 495BI-165 Waterpump Plier 132-240 Circlip Plier for internal Retaining Ring, straight jaws 473-J2 Circlip Plier for internal Retaining Ring, jaws bent at 90° 473-J21 Circlip Plier for external Retaining Ring, straight jaws 474-A2 Circlip Plier for external Retaining Ring, jaws bent at 90° 474-A21	1	2340
0000415307000	OMS-53L	empty module	1	160

OMS-5

MODULE-PLIERS

- for ELORA-roller tool cabinets
- black, with yellow signal colour
- oil and grease resistant
- chemical resistant
- Width: 41,0 cm, Depth: 18,9 cm
- hard foam insert



Code	Number	Contents	Pieces	Weight/g
0000410501000	OMS-5	Snipe Nose Plier with side cutter, straight pattern 470BI-200 Round Nose Plier with long jaws 477BI-170 Heavy Duty Side Cutter 490BI-165 Combination Plier, German pattern 495BI-185 Waterpump Plier 132-240	1	1200
0000410507000	OMS-5L	empty module	1	80

OMS-42

MODULE-VDE PLIERS

- for ELORA-roller tool cabinets
- black, with yellow signal colour
- oil and grease resistant
- chemical resistant
- Width: 41,0 cm, Depth: 18,9 cm
- hard foam insert

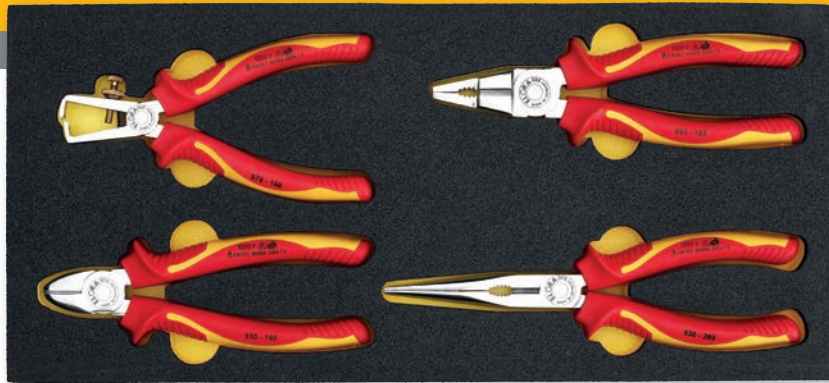

Code	Number	Contents	Pieces	Weight/g
0000414201000	OMS-42	VDE Universal Side Cutter with handle insulation 950-160 VDE Combination Plier with Handle Insulation 960-185 VDE Wire Stripper with Handle Insulation 970-160 VDE Snipe Nose Plier with Handle Insulation 930-205	1	900
0000414207000	OMS-42L	empty module	1	60

OMS-20

MODULE-CIRCLIP PLIER

- for ELORA-roller tool cabinets
- black, with yellow signal colour
- oil and grease resistant
- chemical resistant
- Width: 41,0 cm, Depth: 18,9 cm
- hard foam insert

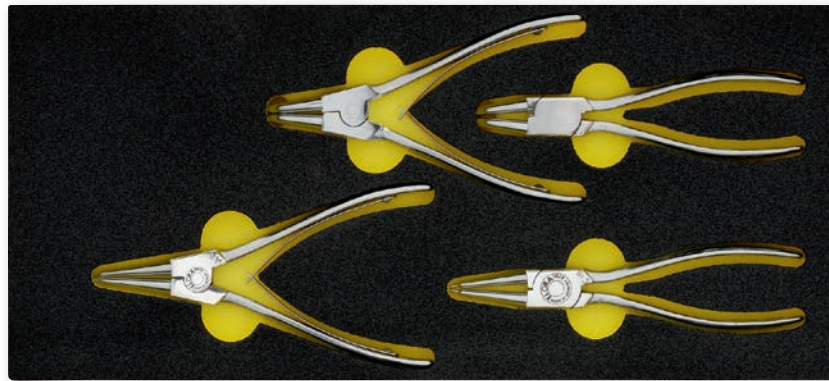

Code	Number	Contents	Pieces	Weight/g
0000412001000	OMS-20	Circlip Plier for internal Retaining Ring, straight jaws 473-J2 Circlip Plier for internal Retaining Ring, jaws bent at 90° 473-J21 Circlip Plier for external Retaining Ring, straight jaws 474-A2 Circlip Plier for external Retaining Ring, jaws bent at 90° 474-A21	1	650
0000412007000	OMS-20L	empty module	1	80

OMS-12

MODULE-HAND STRIKING TOOLS

- for ELORA-roller tool cabinets
- black, with yellow signal colour
- oil and grease resistant
- chemical resistant
- Width: 41,0 cm, Depth: 18,9 cm
- hard foam insert



Code	Number	Contents	Pieces	Weight/g
0000411201000	OMS-12	Flat Chisel, flat oval 260-200 Centre Punch 265-10 Parallel Pin Punch 271-2, 3, 4, 5, 6, 8 Engineer's Hammer, German Pattern 1665-500	1	1520
0000411207000	OMS-12L	empty module	1	80

OMS-45

MODULE-FILES AND HAND STRIKING TOOLS

- for ELORA-roller tool cabinets
- black, with yellow signal colour
- oil and grease resistant
- chemical resistant
- Width: 41,0 cm, Depth: 57,3 cm
- hard foam insert



Code	Number	Contents	Pieces	Weight/g
0000414501000	OMS-45	Flat Chisel, flat oval 260-200 Cape Chisel, flat oval 261-200 Centre Punch 265-10 Parallel Pin Punch 271-3, 4, 5, 6, 8 Three Square Hollow Ground Scraper 272-150 Engineers File 208-2x200 Rectangular File 246-2x200 Half Round File 247-2x200	1	4410
0000414507000	OMS-45L	empty module	1	160

OMS-8

MODULE-HAND STRIKING TOOLS

- for ELORA-roller tool cabinets
- black, with yellow signal colour
- oil and grease resistant
- chemical resistant
- Width: 41,0 cm, Depth: 18,9 cm
- hard foam insert

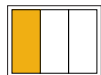

Code	Number	Contents	Pieces	Weight/g
0000410801000	OMS-8	Flat Chisel, flat oval 260-150 Flat Chisel, octagonal 262-150 Cape Chisel, flat oval 261-150	1	2200
0000410807000	OMS-8L	empty module	1	80

OMS-54

MODULE TESTING AND MEASURING TOOLS

- for ELORA-roller tool cabinets
- black, with yellow signal colour
- oil and grease resistant
- chemical resistant
- Width: 41,0 cm, Depth: 18,9 cm
- hard foam insert

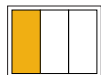
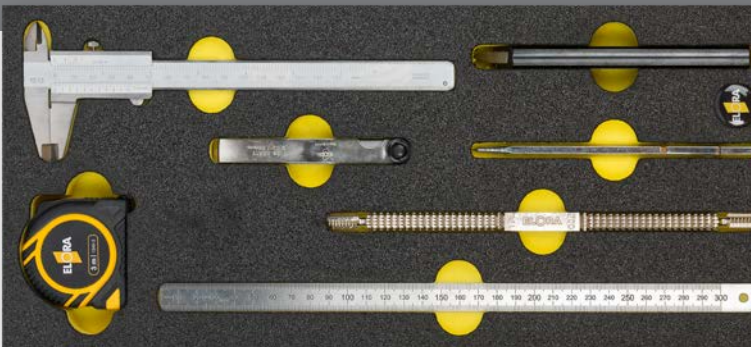

Code	Number	Contents	Pieces	Weight/g
0000415401000	OMS-54	Precision Vernier Caliper 1513 Thread Restoring File 258 MM Carbide Hexagon Engineer's Scriber 1592 Feeler Gauge 188-26M	1	755
0000415407000	OMS-54L	empty module	1	80

WS OMS-5

INDUSTRIAL

► suitable for all Roller Tool cabinets and Work Bench 1811-L

Code	Number	Contents	Pieces 	Weight/g
0000501220005	WS OMS-5	217 Tools	1 assortment	22710
OMS-46		<p>1440-MU Socket Set 1/4", 30 pcs. </p> <p>Bitbox 1/4", 36 pcs. </p> <p>Screwdriver Bit 1/4" for Inside TORX® Screws </p> <p>3050-TX 6, 7, 8, TX 9, TX 10</p> <p>Screwdriver Bit 1/4" for Inside TORX® Safety Screws </p> <p>3070-TTX 10, 15, 27</p> <p>Socket Converter 1/4" 1450-16, 1/4" </p> <p>Bihexagon Sockets 1/2" </p> <p>770-LM 10, 11, 12, 13, 14, 15, 16, 17, 18, 19, 20, 21, 22, 23, 24, 25, 26, 27, 30, 32 mm</p> <p>Reversible Ratchet 1/2" 770-L1D</p> <p>Sliding T-Bar 1/2" 770-L3</p> <p>Extension Bar 1/2" 50 mm 770-L35</p> <p>Extension Bar 1/2", swivelling 75 mm 770-L4V</p> <p>Extension Bar 1/2", swivelling 125 mm 770-L5V</p> <p>Extension Bar 1/2", swivelling 250 mm 770-L6V</p> <p>Universal Joint 1/2" 770-L7</p> <p>Socket Converter 1/2" 770-L13, 3/8" </p> <p>Socket Converter 1/2" 770-L14, 1/2" </p> <p>Screwdriver Sockets 1/2" for inside Hexagon Screws </p> <p>3210-IN 7, IN 8, IN 10, IN 12, IN 14, IN 17, IN 19, IN 22</p> <p>Screwdriver Sockets 1/2" for Inside TORX® Screws </p> <p>3245-TX 45, TX 50, TX 55, TX 60</p> <p>Sockets 1/2" for Outside TORX® Screws </p> <p>770-LTXE 11, 12, 14, 16, 18, 20, 24 mm</p>	123-pcs.	
OMS-48		<p>QUATROLIT®-2C-Screwdriver for plain slotted screws </p> <p>545-IS 75, 100, 125, 150, 175</p> <p>Screwdriver for plain slotted screws, short version </p> <p>543-IS 60</p> <p>Screwdriver for cross slotted screws, short version </p> <p>555-PH 2</p> <p>QUATROLIT®-2C-Screwdriver for cross slotted screws </p> <p>547-PH 1, 2, 3</p> <p>Electronic Screwdriver for plain slotted screws </p> <p>600-IS 1,5x60, 1,8x60, 2,5x75, 3,0x100</p> <p>Electronic Screwdriver for cross slotted screws </p> <p>610-PH 00, PH 0</p> <p>Screwdriver for Inside TORX® screws </p> <p>760TX-6, 7, 8, 9, 10, 15, 20, 25, 27, 30</p> <p>Magnetizer-Demagnetizer 237</p>	27-pcs.	
OMS-50		<p>Combination Spanners, cranked</p> <p>205- 6, 7, 8, 9, 10, 11, 12, 13, 14, 15, 16, 17, 18, 19, 20, 21, 22, 23, 24, 25, 26, 27, 28, 30, 32 mm</p> <p>Double Open-Ended Spanners DIN 3110</p> <p>100- 6x7, 8x9, 10x11, 12x13, 14x15, 16x17, 18x19, 20x22, 21x23, 24x27, 25x28, 30x32 mm</p>	37-pcs.	
OMS-53		<p>Grip Plier with Wire Cutter, for round and flat material 500-250</p> <p>Universal Scissors, straight 498-1</p> <p>Heavy Duty Side Cutter 490BI-165</p> <p>Snipe Nose Plier with side cutter, straight pattern Form 470BI-165</p> <p>Combination Plier, German pattern 495BI-165</p> <p>Waterpump Plier 132-240</p> <p>Circlip Plier for internal Retaining Ring, straight jaws 473-J2</p> <p>Circlip Plier for internal Retaining Ring, jaws bent at 90° 473-J21</p> <p>Circlip Plier for external Retaining Ring, straight jaws 474-A2</p> <p>Circlip Plier for external Retaining Ring, jaws bent at 90° 474-A21</p>	10-pcs.	
OMS-45		<p>Flat Chisel, flat oval 260-200</p> <p>Cape Chisel, flat oval 261-200</p> <p>Centre Punch 265-10</p> <p>Parallel Pin Punch 271-3, 4, 5, 6, 8</p> <p>Three Square Hollow Ground Scraper 272-150</p> <p>Engineers File 208-2x200</p> <p>Rectangular File 246-2x200</p> <p>Half Round File 247-2x200</p> <p>Round File 248-2x200</p> <p>Cutter 281-P</p> <p>Seal Flat Scraper 290</p> <p>Rubber Mallet 1620-65</p> <p>Engineer's Hammer, German Pattern 1665-300</p> <p>Dead-Blow Nylon Soft Faced Hammer 1690-40</p> <p>Mounting Bar 166</p> <p>Measuring Tape 1546-3</p>	19-pcs.	

WS OMS-6

AUTOMOTIVE

► suitable for all Roller Tool cabinets and Work Bench 1811-L

01

Code	Number	Contents	Pieces	Weight/g
0000501220006	WS OMS-6	177 Tools	1 assortment	25990
OMS-49		<p>Bi-Hexagon Sockets ○ 870- 7, 8, 9, 10, 11, 12, 13, 14, 15, 16, 17, 18, 19, 20, 21, 22 mm Screwdriver Sockets ● 3510-IN 3, 4, 5, 6, 7, 8, 9, 10 Screwdriver Sockets long for inside hexagon screws ● 3510-INL 4x100, 5x100, 6x100, 8x100, 10x130 Screwdriver Sockets for inside-TORX® screws ★ 3244-TX 15, 20, 25, 27, 30, 40, 45, 50 Screwdriver Sockets for inside multi-point B & S and XZN screws ● 3530-XZN 5, 6, 8, 10 Screwdriver Sockets for Outside-TORX® screws ⊕ 870-TXE 10, 11, 12, 14 Reversible Ratchet 870-1D Sliding T-Bar 870-8 Universal Joint 870-9 Extension Bar, swivelling 50 mm 870-3V Extension Bar, swivelling 125 mm 870-35V Extension Bar, swivelling 150 mm 870-4V Socket Converter 870-10, 1/4" ■ 3/8" ○ Socket Converter 770-L14, 1/2" ■ 3/8" ○</p>		
53-pcs.				
OMS-51		<p>Combination Spanners, bent 203- 6, 7, 8, 9, 10, 11, 12, 13, 14, 15, 16, 17, 18, 19, 21, 22, 24, 27, 30, 32, mm Double-Ended Ring Spanners, DIN 838 110- 6x7, 8x9, 10x11, 12x13, 14x15, 16x17, 18x19, 20x22, 21x23, 24x27, 25x28, 30x32 mm Combination Spanner with Joint-Ring Ratchet 204R- 8, 9, 10, 11, 12, 13, 14, 15, 16, 17, 18, 19 mm Adapter Drives for bits 1/4", 3/8", 1/2" und 1/4" Bit-Adaptor 118- 1, 2, 3, 4</p>		
48-pcs.				
OMS-53		<p>Grip Plier with Wire Cutter, for round and flat material 500-250 Universal Scissors, straight 498-1 Heavy Duty Side Cutter 490BI-165 Snipe Nose Plier with side cutter, straight pattern Form 470BI-165 Combination Plier, German pattern 495BI-165 Waterpump Plier 132-240 Circlip Plier for internal Retaining Ring, straight jaws 473-J2 Circlip Plier for internal Retaining Ring, jaws bent at 90° 473-J21 Circlip Plier for external Retaining Ring, straight jaws 474-A2 Circlip Plier for external Retaining Ring, jaws bent at 90° 474-A21</p>		
10-pcs.				
OMS-47		<p>Combination Spanner with Ring Ratchet, reversible 204-J 8, 10, 12, 13, 17, 19 mm ○ Double-Ended Ring Spanner for outside TORX®-Screws 119TXE- 6x8, 10x12, 14x18, 20x24 mm ⊕ Open Ring Spanner 121-10x11 mm ○ Adjustable Wrench 60-12 MB Spark Plug Socket 1/2" ○ 771-LTZ 16, 18, 20, 8 mm Socket Converter 770-L14, 1/2" ■ 3/8" ○ Impact Socket 1/2" ○ 790LTP-17, 19, 21 mm Torque Wrench with Vernier Scale 2179-60 10-60 Nm, 2179-200 40-200 Nm Engineer's Hammer, German Pattern 1665-500 Feeler Gauge 188-13 M Tyre Lever 165-300, 165-500 Brush for Brake Service 293 BS Seal Flat Scraper 290-1</p>		
39-pcs.				
OMS-48		<p>QUATROLIT®-2C-Screwdriver for plain slotted screws ⊖ 545-IS 75, 100, 125, 150, 175 Screwdriver for plain slotted screws, short version ⊖ 543-IS 60 Screwdriver for cross slotted screws, short version ⊕ 555-PH 2 QUATROLIT®-2C-Screwdriver for cross slotted screws ⊕ 547-PH 1, 2, 3 Electronic Screwdriver for plain slotted screws ⊖ 600-IS 1,5x60, 1,8x60, 2,5x75, 3,0x100 Electronic Screwdriver for cross slotted screws ⊕ 610-PH 00, PH 0 Screwdriver for Inside TORX® screws ★ 760TX-6, 7, 8, 9, 10, 15, 20, 25, 27, 30 Magnetizer-Demagnetizer 237</p>		
27-pcs.				

MS-2

MODULE-COMBINATION SPANNERS, CRANKED

- ▶ black, with transparent cover
- ▶ Width: 31,5 cm, Depth: 14,5 cm
- ▶ stable ABS plastic



Code	Number	Contents	Pieces	Weight/g
0000502001000	MS-2	Combination Spanners, cranked 205- 8, 10, 11, 13, 14, 17, 19, 22 mm	1	976
0000502007000	MS-2L	empty module	1	140

MS-6

MODULE--COMBINATION SPANNERS, BENT

- ▶ black, with transparent cover
- ▶ Width: 31,5 cm, Depth: 14,5 cm
- ▶ stable ABS plastic



Code	Number	Contents	Pieces	Weight/g
0000506001000	MS-6	Combination Spanners, bent 203-8, 10, 11, 13, 17, 19, 22, 24 mm	1	1028
0000502007000	MS-2L	empty module	1	140

MS-10

MODULE-COMBINATION SPANNER WITH RING RATCHET

- ▶ black, with transparent cover
- ▶ Width: 31,5 cm, Depth: 14,5 cm
- ▶ stable ABS plastic



Code	Number	Contents	Pieces	Weight/g
0000510001000	MS-10	Combination Spanners with Ring Ratchets 204- 8, 9, 10, 12, 13, 14, 17, 19 mm	1	940
0000502007000	MS-2L	empty module	1	140

MS-50

MODULE-SOCKET SET 1/4"

- black, with transparent cover
- Width: 31,5 cm, Depth: 14,5 cm
- stable ABS plastic



6,3

1/4"



Code	Number	Contents	Pieces	Weight/g
0000550001000	MS-50	Screwdriver Sockets for inside hexagon screws ★ 3243-TX 8, 9, 10, 15, 20, 25, 27, 30, 40 Sockets for outside TORX® screws ☼ 1455-TXE 4, 5, 6, 7, 8, 10, 11 Screwdriver Sockets for inside hexagon screws ● 1455-IN 3, 4, 5, 6, 8 mm Hexagon Sockets ○ 4, 4,5, 5, 5,5, 6, 7, 8, 9, 10, 11, 12, 13, 14 mm Reversible Ratchet 1450-1D Spinner Handle 1450-3 Sliding T-Bar 1450-4 Universal Joint 1450-8 Extension Bar 50 mm 1450-11 Extension Bar 100 mm 1450-5 Extension Bar 150 mm 1450-12	1	892
0000550007000	MS-50L	empty module	1	95

MS-11/12

MODULE-SOCKET SET 1/2"

- black, with transparent cover
- Width: 31,5 cm, Depth: 14,5 cm
- stable ABS plastic



12,5

1/2"



Code	Number	Contents	Pieces	Weight/g
0000511001000	MS-11	Bihexagon Sockets ○ 770-LM 10, 11, 12, 13, 14, 15, 16, 17, 18, 19, 20, 22 mm Reversible Ratchet 770-L1D Extension Bar 250 mm 770-L6 Sliding T-Bar 770-L3	1	2140
0000512001000	MS-12	same as MS-11, but all sockets in hexagon pattern ○	1	2140
0000511007000	MS-11L	empty module	1	95

MS-14

MODULE-TORX®-TOOLS

- black, with transparent cover
- Width: 31,5 cm, Depth: 14,5 cm
- stable ABS plastic



12,5

1/2"



Code	Number	Contents	Pieces	Weight/g
0000514001000	MS-14	Screwdriver Sockets for inside TORX® screws ☉ 3245 TX 20, 25, 27, 30, 40, 45, 50, 55, 60 TORX®-Ball End Key Set ☉ 162S-TXKU 9, 10, 15, 20, 25, 27, 30, 40	1	918
0000513007000	MS-13L	empty module	1	95

MS-13

MODULE-ALLEN KEYS SOCKET SET 1/2"

- black, with transparent cover
- Width: 31,5 cm, Depth: 14,5 cm
- stable ABS plastic



12,5

1/2"



mm

Code	Number	Contents	Pieces	Weight/g
0000513001000	MS-13	Screwdriver Socket 1/2" for Inside hexagon screws ● 3210 IN 4, 5, 6, 8, 10, 12, 14, 17, 19 mm Ball End Hexagon Key Set, extra long, 1,5-10 mm 159SKU	1	1486
0000513007000	MS-13L	empty module	1	95

MS-38

MODULE-QUATROLIT® 2C-SCREWDRIVER

- black, with transparent cover
- Width: 31,5 cm, Depth: 14,5 cm
- stable ABS plastic



Code	Number	Contents	Pieces	Weight/g
0000538001000	MS-38	QUATROLIT®-2C-Screwdrivers for plain slotted screws ☰ 545-IS 75 (0,6x3,5) 100 (0,8x4,0) 125 (1,0x5,5) 150 (1,2x6,5) QUATROLIT®-2C-Screwdrivers for cross slotted screws ☩ 547-PH 1, 2	1	455
0000531007000	MS-31L/41L	empty module	1	96

MS-39

MODULE-QUATROLIT® 2C-SCREWDRIVER

- black, with transparent cover
- Width: 31,5 cm, Depth: 14,5 cm
- stable ABS plastic



Code	Number	Contents	Pieces	Weight/g
0000539001000	MS-39	QUATROLIT®-2C-Screwdrivers for plain slotted screws ☰ 545-IS 75 (0,6x3,5) 100 (0,8x4,0) 125 (1,0x5,5) 150 (1,2x6,5) QUATROLIT®-2C-Screwdrivers for cross slotted screws ☩ 549-PZ 1, 2	1	456
0000531007000	MS-31L/41L	empty module	1	96

MS-36

MODULE-QUATROLIT® 2C-SCREWDRIVER

- black, with transparent cover
- Width: 31,5 cm, Depth: 14,5 cm
- stable ABS plastic



Code	Number	Contents	Pieces	Weight/g
0000536001000	MS-36	QUATROLIT®-2C-Screwdrivers for plain slotted screws ☰ 539-IS 75 (0,6x3,5) 100 (1,0x5,5) 125 (1,2x6,5) 150 (1,2x8,0) QUATROLIT®-2C-Screwdrivers for cross slotted screws ☩ 559-PH 1, 2	1	574
0000531007000	MS-31L/41L	empty module	1	96

MS-37

MODULE-QUATROLIT® 2C-SCREWDRIVER

- black, with transparent cover
- Width: 31,5 cm, Depth: 14,5 cm
- stable ABS plastic



Code	Number	Contents	Pieces	Weight/g
0000537001000	MS-37	QUATROLIT®-2C-Screwdrivers for plain slotted screws ☰ 539-IS 75 (0,6x3,5) 100 (1,0x5,5) 125 (1,2x6,5) 150 (1,2x8,0) QUATROLIT®-2C-Screwdrivers for cross slotted screws ☩ 569-PZ 1, 2	1	575
0000531007000	MS-31L/41L	empty module	1	96

MS-40

MODULE-ENGINEER SCREWDRIVER

- black, with transparent cover
- Width: 31,5 cm, Depth: 14,5 cm
- stable ABS plastic



Code	Number	Contents	Pieces	Weight/g
0000540001000	MS-40	Screwdriver for plain slotted screws with wooden handle \ominus 636-IS 75 (0,6x3,5) 90 (0,8x4,5) 100 (1,0x5,5) 125 (1,2x6,5) Screwdriver for cross slotted screws with wooden handle \oplus 656-PH 1, 2	1	500
0000531007000	MS-31L/41L	empty module	1	96

MS-41

MODULE-ENGINEER SCREWDRIVER

- black, with transparent cover
- Width: 31,5 cm, Depth: 14,5 cm
- stable ABS plastic



Code	Number	Contents	Pieces	Weight/g
0000541001000	MS-41	Screwdriver for plain slotted screws with wooden handle \ominus 636-IS 75 (0,6x3,5) 90 (0,8x4,5) 100 (1,0x5,5) 125 (1,2x6,5) Screwdriver for cross slotted screws with wooden handle \oplus 658-PZ 1, 2	1	500
0000531007000	MS-31L/41L	empty module	1	96

MS-32

MODUL-VDE-SCREWDRIVER

- black, with transparent cover
- Width: 31,5 cm, Depth: 14,5 cm
- stable ABS plastic

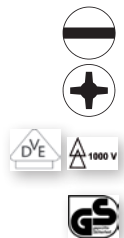

Code	Number	Contents	Pieces	Weight/g
0000532001000	MS-32	VDE-Screwdriver for plain slotted screws \ominus 900-IS 75 (0,4x2,5) 106 (0,6x3,5) 12510 (1,0x5,5) 175 (1,2x8,0) VDE-Screwdriver for cross slotted screws \oplus 910-PH 1, 2	1	518
0000531007000	MS-31L/41L	empty module	1	96

MS-23

MODUL-VDE-PLIERS

- black, with transparent cover
- Width: 31,5 cm, Depth: 14,5 cm
- stable ABS plastic



01

Code	Number	Contents	Pieces	Weight/g
0000523001000	MS-23	VDE Combination Plier with Handle Insulation 960-185 VDE Snipe Nose Plier with Handle Insulation 930-205 VDE Universal Side Cutter with handle insulation 950-160	1	802
0000521007000	MS-21L	empty module	1	96

MS-21

MODULE-PLIERS

- black, with transparent cover
- Width: 31,5 cm, Depth: 14,5 cm
- stable ABS plastic



Code	Number	Contents	Pieces	Weight/g
0000521001000	MS-21	Combination Plier, German pattern 495BI-185 Snipe Nose Plier with Side Cutter, straight pattern 470BI-200 Heavy Duty Side Cutter 490BI-165	1	806
0000521007000	MS-21L	empty module	1	96

MS-25

MODUL-CIRCLIP PLIER SET

- black, with transparent cover
- Width: 31,5 cm, Depth: 14,5 cm
- stable ABS plastic

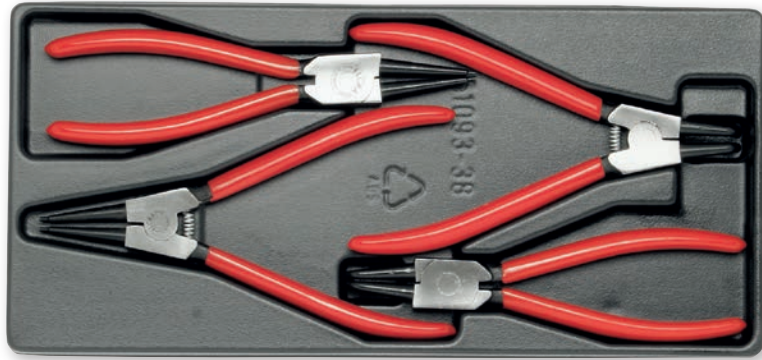

Code	Number	Contents	Pieces	Weight/g
0000525001000	MS-25	Circlip Plier for internal Retaining Ring, straight jaws 383-J2 Circlip Plier for internal Retaining Ring, jaws bent at 90° 383-J21 Circlip Plier for external Retaining Ring, straight jaws 384-A2 Circlip Plier for external Retaining Ring, jaws bent at 90° 384-A21	1	783
0000524007000	MS-25L	empty module	1	96

MS-26

MODUL-CIRCLIP PLIER SET

- black, with transparent cover
- Width: 31,5 cm, Depth: 14,5 cm
- stable ABS plastic

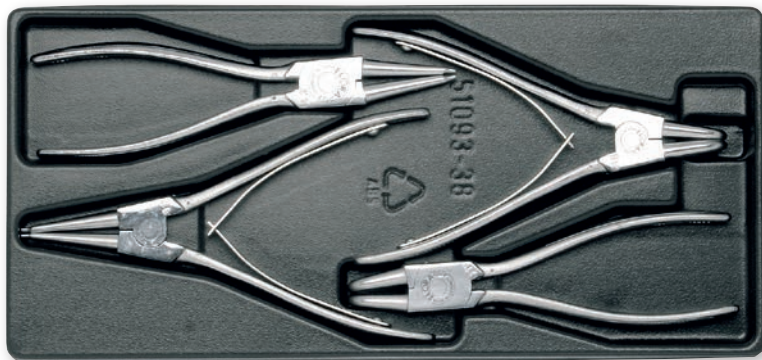

Code	Number	Contents	Pieces	Weight/g
0000526001000	MS-26	Circlip Plier for internal Retaining Ring, straight jaws 473-J2 Circlip Plier for internal Retaining Ring, jaws bent at 90° 473-J21 Circlip Plier for external Retaining Ring, straight jaws 474-A2 Circlip Plier for external Retaining Ring, jaws bent at 90° 474-A21	1	769
0000524007000	MS-25L	empty module	1	96



WS-1M
TOOL ASSORTMENT

- suitable for Tool Cabinet ELORA-No. 1100L
- suitable for all Roller Tool cabinets and Work Bench 1811-L

Code	Number	Contents	Pieces	Weight/g
0000500101000	WS-1M	64 metric tools	1 assortment	8300
205-...	8, 9, 10, 11, 12, 13, 14, 15, 16, 17, 19, 22 mm			
1 pc. each				
770-LM...	10, 11, 12, 13, 14, 15, 16, 17, 19, 22, 24, 27, 30, 32 mm	 		
1 pc. each				
158R-1	2; 2,5; 3; 4; 5; 6; 8; 10 mm			
1 pc. each				
770-L1D	270 mm			
			12,5	1/2"
770-L3	300 mm			
			12,5	1/2"
770-L5/L6	125 mm 250 mm			
1 pc. each			12,5	1/2"
770-L7	75 mm			
			12,5	1/2"
539-IS...	100, 125, 150			
1 pc. each				
545-IS75				
547-PH...	PH1 PH2 PH3			
1 pc. each				
1665-300				
266-K	262-125 mm 262-150 mm 263-125 mm 264-120x10x4 mm 264-120x12x4 mm 265-120x10mm			
1 pc. each				
271-K	271-150x2 mm 271-150x3 mm 271-150x4 mm 271-150x5 mm 271-150x6 mm 271-150x8 mm			
1 pc. each				
132-240				
495-BI 165				
246-2x200				
247-2x200				
248-2x200				

01

WS-2...

TOOL ASSORTMENT

- suitable for tool cabinet ELORA-No. 1100L
- suitable for all Roller Tool cabinets and Work Bench 1811-L
- suitable for cantilever tool box ELORA-Nr. 810-L

01

Code	Number	Contents	Pieces	Weight/g
0000500201000	WS-2M	89 metrische Werkzeuge	1 assortment	15000
0000600201000	WS-2A	88 inch tools	1 assortment	14500

MM-Assortment WS-2M		AF-Assortment WS-2A	
100-...	6x7, 8x9, 10x11, 12x13, 14x15, 16x17, 18x19, 20x22, 24x27, 30x32 mm		100-... 1/4x5/16, 5/16x3/8, 3/8 x7/16, 7/16x1/2, 1/2x9/16, 9/16x5/8, 5/8x11/16, 11/16x3/4, 3/4x7/8, 13/16x7/8, 15/16x1, 1.1/16x1.1/4 AF
je 1 Stück			je 1 Stück
110-...	6x7, 8x9, 10x11, 12x13, 14x15, 16x17, 18x19, 20x22, 24x27, 30x32 mm		110-... 1/4x5/16, 3/8x7/16, 1/2x9/16, 5/8x11/16, 3/4x25/32, 13/16x7/8, 15/16x1, 1.1/16x1.1/4 AF
je 1 Stück			je 1 Stück
770-LM...	10, 11, 12, 13, 14, 15, 16, 17, 18, 19, 21, 22, 24, 27, 30, 32 mm		770-LM... 3/8, 7/16, 1/2, 9/16, 19/32, 5/8, 11/16, 3/4, 13/16, 25/32, 7/8, 15/16, 1, 1.1/8, 1.1/4 AF
je 1 Stück			je 1 Stück
158-R1	2; 2,5; 3; 4; 5; 6; 8; 10 mm		158-R1 1/16, 5/64, 3/32, 1/8, 5/32, 3/16, 7/32, 1/4 AF
je 1 Stück			je 1 Stück
188-13M	0,05, 0,10, 0,15, 0,20, 0,25, 0,30, 0,40, 0,50, 0,60, 0,70, 0,80, 0,90, 1,00		188-13M .002, .003, .004, .005, .006, .008, .010, .012, .015, .020, .025, .030, .035
je 1 Stück			je 1 Stück

One piece of each tool is included in both tool assortments WS-2M and WS-2A

770-L1D	270 mm		1/2" 12,5	
770-L3	300 mm		1/2" 12,5	
770-L5/L6	125 mm 250 mm		1/2" 12,5	
je 1 Stück				
770-L7	75 mm		1/2" 12,5	
222-16x20,8				
545-IS...	75, 100, 125, 150, 200			
547-PH...	PH1 PH2 PH3			
je 1 Stück				
246-2x200				
247-2x200				
248-2x200				
132-240				
500-250				
1665-500				
470-BI 200				
490-BI 165				
495-BI 185				
1660-32				
251-45				
60-8A				
242KM-250	250 ml			
165-500	2 Stück			
189				
1546-3				
249 S6				
250-4				
266-K	262-125, 150 mm 263-125 mm 264-120x10x4 mm 264-120x12x4 mm 265-120x10mm			
je 1 Stück				

WS-3M

TOOL ASSORTMENT

- suitable for tool cabinet ELORA-No. 1100L
- suitable for all Roller Tool cabinets and Work Bench 1811-L
- suitable for cantilever tool box ELORA-Nr. 810-L

Code	Number	Contents	Pieces	Weight/g
0000500301000	WS-3M	80 metric tools	1 assortment	17500
100-...	6x7, 8x9, 10x11, 12x13, 14x15, 16x17, 18x19, 20x22, 21x23, 24x27, 25x28, 30x32 mm			
1 pc. each				
110-...	6x7, 8x9, 10x11, 12x13, 14x15, 16x17, 18x19, 20x22, 21x23, 24x27, 25x28, 30x32 mm			
1 pc. each				
205-...	8, 9, 10, 11, 13, 17, 19, 22 mm			
1 pc. each				
770-LM...	10, 11, 12, 13, 14, 15, 16, 17, 18, 19, 20, 21, 22, 23, 24, 25, 26, 27, 30, 32 mm			12,5 1/2"
1 pc. each				
770-L1D	270 mm			12,5 1/2"
770-L3	300 mm			12,5 1/2"
770-L5/L6	125 mm 250 mm			12,5 1/2"
1 pc. each				
770-L7	75 mm			12,5 1/2"
222-16x20,8				
165-500	2 pcs.			
60-8A				
60-10A				
132-240				
470-BI 200				
490-BI 165				
495-BI 185				
473-J2				IN
473-J21				IN
539-IS...	100, 125, 150, 200		1 pc. each	
545-IS...	75, 150		1 pc. each	
547-PH...	PH1 PH2		1 pc. each	
260-150				
261-150				
265-10				
264-...	264-120x10x2 mm 264-120x10x3 mm 264-120x12x4 mm 264-120x12x5 mm 264-120x12x6 mm		1 pc. each	
1665-500				
246-2x200				
247-2x200				
248-2x200				
189				

01

WS-4M

TOOL ASSORTMENT "MECHATRONIC"

- suitable for tool cabinet ELORA-No. 1100L
- suitable for all Roller Tool cabinets and Work Bench 1811-L
- suitable for cantilever tool box ELORA-Nr. 810-L
- suitable for hard protective case ELORA-No. 1380-L and hard protective trolley case ELORA-No. 1381-L

01

Code	Number	Contents	Pieces	Weight/g
0000500401101	WS-4M	131 metric tools	1 assortment	22800
205-...	6, 7, 8, 9, 10, 11, 12, 13, 14, 15, 16, 17, 18, 19, 20, 21, 22 mm			
1 pc. each				
1455-M...	4, 4.5, 5, 5.5, 6, 7, 8, 9, 10, 11, 13 mm			
1 pc. each		6,3 1/4"		
770-LM...	10, 11, 12, 13, 14, 15, 16, 17, 19, 22, 24, 27, 30, 32 mm			
1 pc. each		12,5 1/2"		
159-...	1.5, 2, 2.5, 3, 4, 5, 6, 8, 10, 12 mm			
1 pc. each				
1450-1D	145 mm		6,3 1/4"	
1450-4	270 mm		6,3 1/4"	
1450-5	100 mm		6,3 1/4"	
1450-8	45 mm		6,3 1/4"	
1450-3	150 mm		6,3 1/4"	
1450-16	25 mm		6,3 1/4"	
770-L1D	270 mm		12,5 1/2"	
770-L3	300 mm		12,5 1/2"	
770-L5/L6	125 mm 250 mm		12,5 1/2"	
1 pc. each				
770-L7	75 mm		12,5 1/2"	
1080				
1513				
1591				
1543-3				
242KM-125	125 ml			
466A-16,0				
930-205				
960-185				
950-160				
900IS-...	108, 12508			
1 pc. each				
910PH-...	PH1 PH2			
1 pc. each				
564N				
561				
600-IS...	1,2 x 60, 1,5 x 60 2,0 x 60			
610-PH...	00 x 60 0 x 60			
4680-MH E				
4550-F E				
262-150				
265-10				
271-...	3,0, 5,0			
1 pc. each				
246-2x200				
207-2x200				
248-2x200				
189				
1665-500				
1690-30				
3436-S36	Bit-Box 36 pcs.			

WS-5M

TOOL ASSORTMENT

- suitable for tool cabinet ELORA-No. 1100L
- suitable for all Roller Tool cabinets and Work Bench 1811-L

Code	Number	Contents		Pieces	Weight/g
0000500501100	WS-5M	145 metric tools		1 assortment	28600
100-...	6x7; 8x9; 10x11; 12x13; 14x15; 16x17; 18x19; 20x22; 21x23; 24x27; 25x28; 30x32 mm				
1 pc. each					
110-...	6x7; 8x9; 10x11; 12x13; 14x15; 16x17; 18x19; 20x22; 21x23; 24x27; 25x28; 30x32 mm				
1 pc. each					
205-...	8; 9; 10; 11; 12; 13; 14; 15; 16; 17; 18; 19; 20; 21; 22 mm				
1 pc. each					
770-LM...	10; 11; 12; 13; 14; 15; 16; 17; 18; 19; 21; 22; 23; 24; 25; 26; 27; 30; 32 mm		12,5 1/2"		
1 pc. each					
1455-M...	4; 4,5; 5; 5,5; 6; 7; 8; 9; 10; 11; 13 mm		6,3 1/4"		
1 pc. each					
158R-1	2; 2,5; 3; 4; 5; 6; 8; 10 mm				
1 pc. each					
188-13M	0,05; 0,10; 0,15; 0,20; 0,25; 0,30; 0,40; 0,50; 0,60; 0,70; 0,80; 0,90; 1,00				
1 pc. each					
770-L1D	270 mm		12,5 1/2"		
770-L2	300 mm		12,5 1/2"		
770-L3	300 mm		12,5 1/2"		
770-L5/L6	125 mm 250 mm		12,5 1/2"		
1 pc. each					
770-L7	75 mm		12,5 1/2"		
1450-1D	145 mm		6,3 1/4"		
1450-3	150 mm		6,3 1/4"		
1450-4	270 mm		6,3 1/4"		
1450-5	100 mm		6,3 1/4"		
1450-8	270 mm		6,3 1/4"		
222-16x20,8	16x20,8 mm				
165-500	500 mm				
2 pcs.					
170-...	170-24x27 mm 170-32x38 mm				
1 pc. each					
171-500x18	500 mm				
195CV-17	17; 19; 22 mm; 11/16" AF				
60-...	60-6A, 160mm / 6"; 60-8A, 210mm / 8"; 60-10A, 260mm / 10"				
1 pc. each					
480-330	330 mm				
132-...	132-190 mm, 132-240 mm				
1 pc. each					
500-250	250 mm				
470-BI 200	200 mm				
471-45 BI 200	200 mm				
485-BI 165	165 mm				
490-BI 165	165 mm				
495-BI 185	185 mm				
473-J2	180 mm				
473-J21	165 mm				
474-...	A2 A21				
1 pc. each					
242KM-250	250 ccm				
539-IS...	539-IS 100; 150; 200				
1 pc. each					
545-IS...	545-IS 75; 100; 150				
1 pc. each					
543-IS 60					
555-PH1					
547-PH...	547-PH 1; PH 2				
1 pc. each					
260	260-150 mm; 260-200 mm				
1 pc. each					
261-150	150 mm				
264-...	264-120x10x3; 120x12x4; 120x12x5; 120x12x6 mm				
1 pc. each					
265-10	120x10 mm				
189	420 mm				
1665-300	300 g				
1665-35					
266-K	262-125 mm, 262-150 mm 263-125 mm, 264-120x10x4 mm 264-120x12x4 mm, 265-120x10mm				
1 set					
246-1x200	200 mm/8"				
247-2x200	200 mm/8"				
248-2x200	200 mm/8"				
352-S6	Schraubenausdreher Satz 350-6; 8; 11; 14; 18; 24				
1 set					

WS-6M

TOOL ASSORTMENT

- suitable for tool cabinet ELORA-No. 1100L
- suitable for all Roller Tool cabinets and Work Bench 1811-L
- suitable for cantilever tool box ELORA-Nr. 810-L
- suitable for hard protective case ELORA-No. 1380-L and hard protective trolley Case ELORA-No. 1381-L
- suitable for installation tool bag ELORA-No. 1385-L

01

Code	Number	Contents	Pieces	Weight/g
0000500601000	WS-6M	83 metric tools	1 assortment	7800
146-...	4, 4,5, 5, 5,5, 6, 7, 8, 9, 10, 11, 12, 13, 14, 17 mm			
1 pc. each				
113-...	4x4,5, 5x5,5, 6x7, 8x9, 10x11 mm			
1 pc. each				
1455-M...	4, 4,5, 5, 5,5, 6, 7, 8, 9, 10, 11, 12, 13, 14 mm	6,3 1/4"		
1 pc. each				
158-R1	2; 2,5; 3; 4; 5; 6; 8; 10 mm			
1 pc. each				
216-...	4, 4,5, 5, 5,5, 6, 7, 8, 9, 10 mm			
1 pc. each				
1450-1D	145 mm	6,3 1/4"		
1450-3	150 mm	6,3 1/4"		
1450-4	270 mm	6,3 1/4"		
1450-5	100 mm	6,3 1/4"		
1450-8	45 mm	6,3 1/4"		
132-240				
476-BI170		⊞		
477-BI170		●		
490-BI 165		⊗		
494-BI 160		◊		
495-BI 165		⊞		
900IS-...	75, 100, 7506, 108, 12510	GS DVE 1000 V		
1 pc. each				
910PH-...	PH0, PH1, PH2	GS DVE 1000 V		
1 pc. each				
242K-60	60 ml			
237-500				
1665-100				
566-150		GS DVE 1000 V		
1591-250				
257A				
740-...	4,0, 5,5, 8,0	⊞		
1 pc. each				
730-...	1 + 3	⊕		
1 pc. each				
271-...	2, 3, 4, 5			
1 pc. each				

WS-9M

TOOL ASSORTMENT

- suitable for tool cabinet ELORA-No. 1100L
- suitable for all Roller Tool cabinets and Work Bench 1811-L
- suitable for cantilever tool box ELORA-Nr. 810-L
- suitable for hard protective case ELORA-No. 1380-L and hard protective trolley Case ELORA-No. 1381-L
- suitable for Installation tool bag ELORA-No. 1385-L
- suitable for cantilever tool box ELORA-Nr. 800-L, 810-L, 803-L, 813-L

01

Code	Number	Contents	Pieces	Weight/g
0000500901000	WS-9M	48 metric tools	1 assortment	5300
203-...	6, 7, 8, 10, 13, 15, 17, 19 mm			
1 pc. each				
159-S-KK-1	2,5, 3, 4, 5, 6, 8 mm			
1 pc. each				
770-LM...	10, 11, 12, 13, 14, 15, 16, 17, 18, 19, 20, 22			
1 pc. each		12,5 1/2"		
251				
561				
586				
132-240				
1665-200				
260-150				
265-10				
271-4				
321-180				
470-BI200				
490-BI 165				
495-BI 185				
545-IS...	75, 100, 125, 150			
1 pc. each				
547-...	PH1 PH2			
1 pc. each				
770-L1D	270 mm			
			12,5 1/2"	
770-L3	300 mm			
			12,5 1/2"	
770-L6	250 mm			
			12,5 1/2"	
771-LTZ 20,8				
			12,5 1/2"	

WS-8M

PLUMBING TOOL SET

- suitable for tool cabinet ELORA-No. 1100L
- suitable for all Roller Tool cabinets and Work Bench 1811-L
- suitable for hard protective case ELORA-No. 1380-L and hard protective trolley case ELORA-No. 1381-L
- suitable for cantilever tool box ELORA-Nr. 810-L

01

Code	Number	Contents	Pieces	Weight/g
0000500811001	WS-8M	58 metric tools	1 assortment	15000
121-...	8x10, 9x11, 12x14, 13x15, 14x16, 17x19, 21x23, 22x24 mm			
1 pc. each				
204-...	10, 11, 12, 13, 14, 15, 16, 17, 18, 19, 22, 24 mm			
1 pc. each				
159-...	1,5, 2, 2,5, 3, 4, 5, 6, 8, 10, 12 mm			
770-L1ZI	250 mm	12,5 1/2"		
539-IS...	100, 125, 150			
1 pc. each				
559-PH...	PH1 PH2			
1 pc. each				
468-BI				
470-BI 165				
60-12MB				
68SN-1.1/2				
132-240				
301-250				
138				
131-250				
1665-500				
65-2				
179-16				
180-35				
64				
182-42				
365-200x8x10				
362-250				
283HS				
1544H				
561				
189P				
281-90				
1672-1250				
484R-260				
139-100				

WS-10M

ELECTRICIAN TOOL SET

- suitable for tool cabinet ELORA-No. 1100L
- suitable for all Roller Tool cabinets and Work Bench 1811-L
- suitable for hard protective case ELORA-No. 1380-L and hard protective trolley case ELORA-No. 1381-L
- suitable for installation tool bag ELORA-No. 1385-L
- suitable for cantilever tool box ELORA-Nr. 810-L

01

Code	Number	Contents	Pieces	Weight/g
0000501101001	WS-10M	76 metric tools	1 assortment	5800
100-...	14x17, 18x19, 21x23, 22x24			
1 pc. each				
146-...	4, 4,5, 5, 5,5, 6, 7, 8, 9, 10, 11, 12, 13 mm			
1 pc. each				
159-...	1,5, 2, 2,5, 3, 4, 5, 6, 8, 10, 12 mm			
1 pc. each				
1455-M...	4, 4,5, 5, 5,5, 6, 7, 8, 9, 10, 11, 13 mm			
1 pc. each			6,3	1/4"
1450-1D	145 mm			
			6,3	1/4"
1450-4	270 mm			
			6,3	1/4"
1450-5	100 mm			
			6,3	1/4"
1450-8	45 mm			
			6,3	1/4"
1450-3	150 mm			
			6,3	1/4"
543-IS 60				
555-PH1				
549-PZ...	PZ1, PZ2			
1 pc. each				
730-1				
740-...	5,5, 8,0			
1 pc. each				
910PH-...	PH1, PH2			
1 pc. each				
900IS-...	106, 108, 12508, 150			
1 pc. each				
563				
960-185				
				
930-165				
				
920-165				
				
935-45				
				
970-160				
				
61-MB 10				
260-175				
264-...	264-120x10x2 mm, 264-120x10x4 mm			
1 pc. each				
265-10				
365-250x10x15				
1665-300				
132-240				
257-50				
257-S	saw blade, universal			
746				
1591-250				
281				
1546-3				
498-1				